

# INSTALLATION MANUAL

---

PRODUCT: TRANSFER CASE SKID PLATE

APPLICATION: DODGE RAM 1500 (2018-Present)

PART NO: 2333.1507.1.6

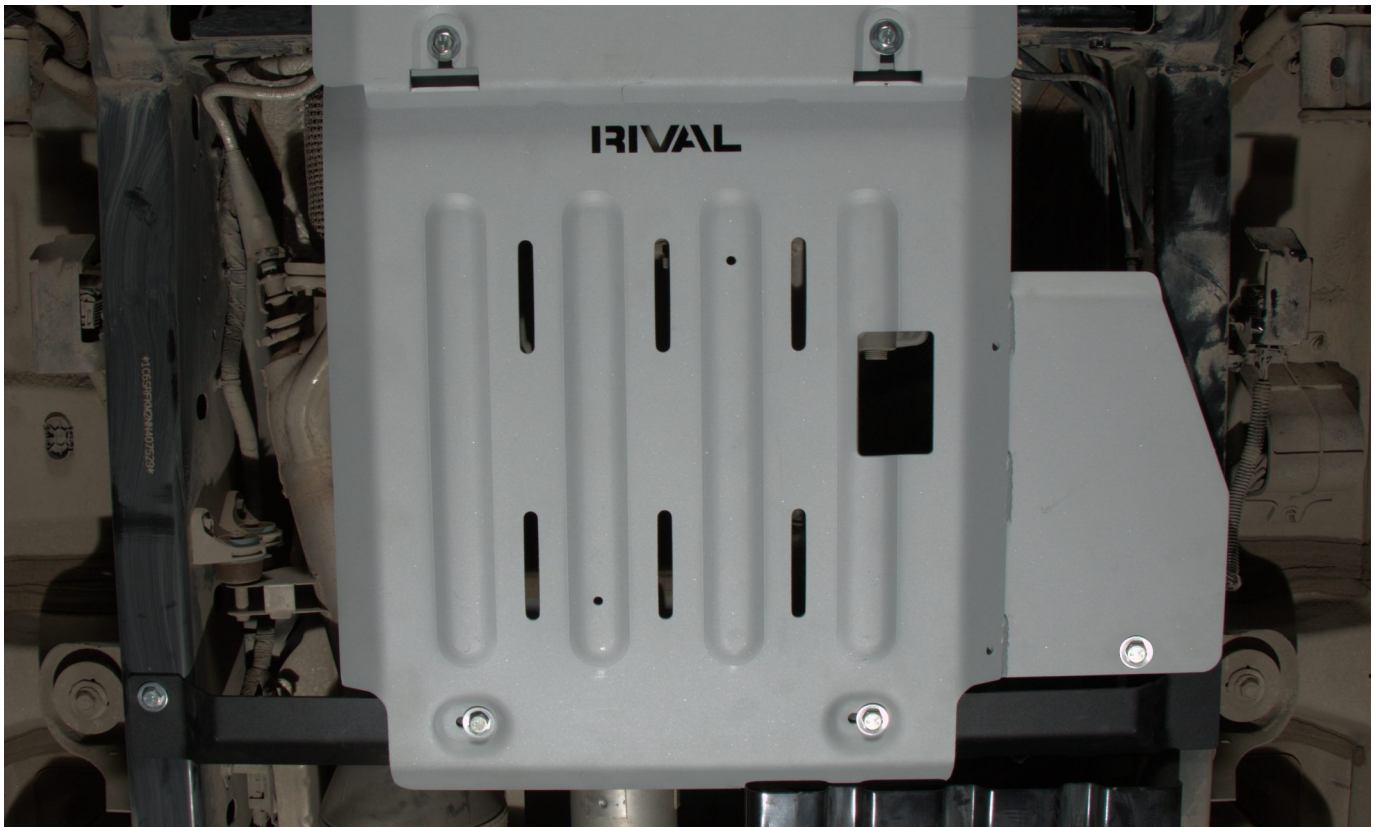

## CAUTION!

To reduce the risk of serious injury or damage to property: Before you start installing and using this product, read the full instructions, pay special attention to the conditions of safe use and recommendations for installation! When installing or maintaining this product, it is necessary to use protective goggles. Check the integrity of the structure and the moment the fastening is tightened every 250 miles (400 kms) of mileage. Do not use this product if there is damage to the structure or fasteners!

## NOTICE

Skid plate is an additional protection, but it can not guarantee to protect against all possible damage in collisions. When driving, be careful of objects and terrain that may damage sensitive parts of the vehicle.

# TRANSFER CASE SKID PLATE

---

Part number: 2333.1507.1.6

Suited to vehicle: Dodge RAM 1500 V-3.0D; AT; 4WD (2018-Present)

Material: Aluminum



## SAFETY NOTICE

---

- \* The RIVAL skid plate is designed to complement the use and design of the specified vehicle under conditions specified by the vehicle manufacturer.
- \* While driving the vehicle at any speed, collision with any other vehicle, animal or object must always be avoided.
- \* Following any collision with any other vehicle, animal or object, the RIVAL skid plate and the vehicle must be inspected by a specialized or suitably qualified vehicle repairer for possible damage to the components and assemblies in order to confirm suitability for further use of the vehicle.
- \* It is strongly recommended that you do not operate a vehicle with a damaged skid plate or its components. In the case of damage, please contact the nearest RIVAL dealer. Vehicle, or where the skid plate has been damaged, is extremely dangerous and must be avoided at all cost.

## INSTALLATION NOTICE

---

- \* The RIVAL skid plate must be mounted and affixed to the vehicle according to this installation manual.
- \* Personal safety during the installation process must be adhered to at all times.
- \* Do not install this skid plate on vehicle models other than those allowed in this manual.
- \* Estimated time for installation: 1 hour.

## REQUIRED TOOLS

---

- \* Basic tool kit
- \* Torque wrench

## TORQUE SETTING

---

- \* M10 - 47 N·m (34.7 lb/ft)

# PARTS LISTING

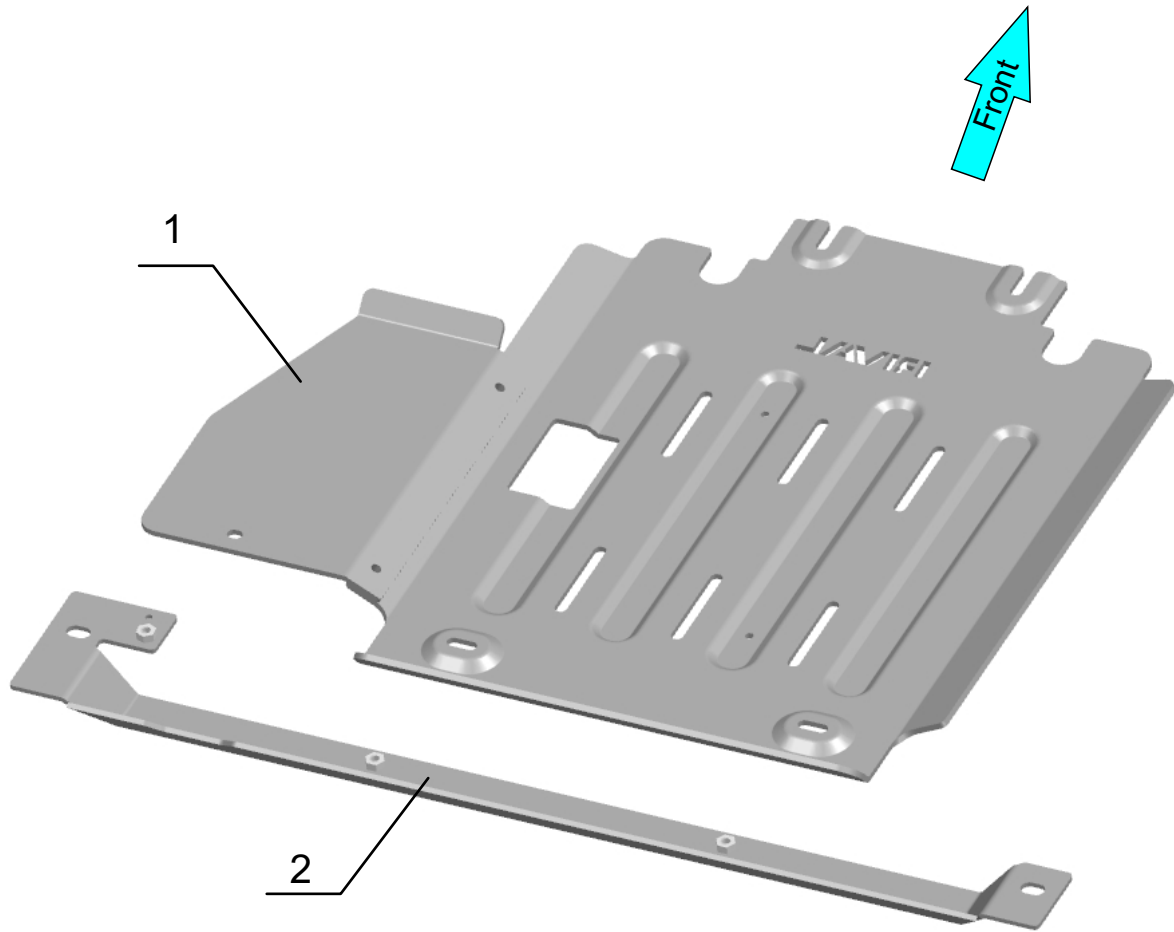

- 1. Transfer case skid plate.....Qty 1
- 2. Crossmember.....Qty 1

# PARTS LISTING

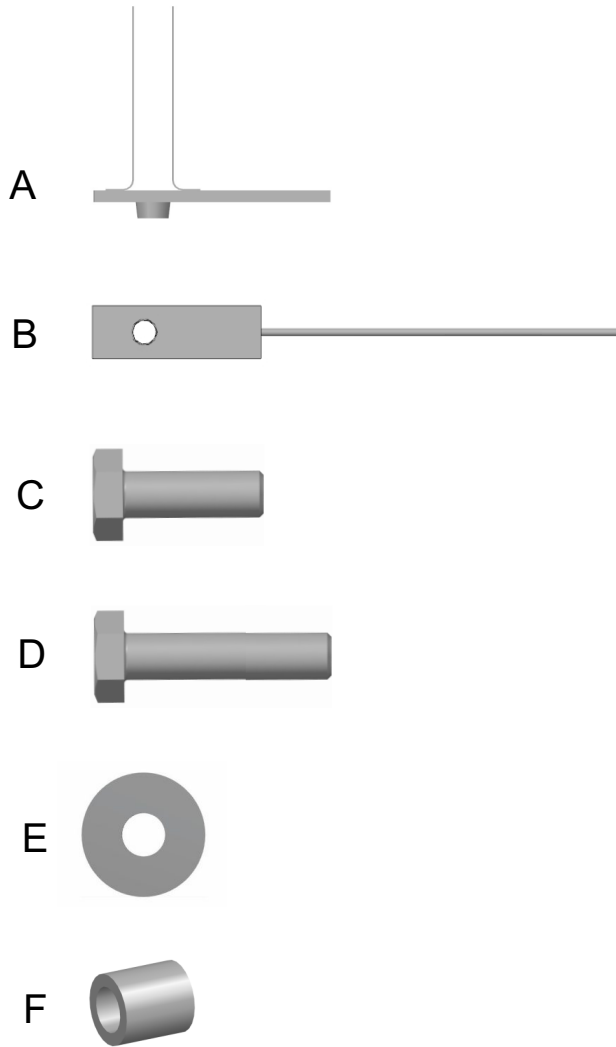

A. Insert nut M10.....	Qty 2
B. Insert nut M10 with wire.....	Qty 2
C. Bolt M10x30.....	Qty 6 (2 pcs. pre-installed)
D. Bolt M10x50.....	Qty 1
E. Flat washer M10.....	Qty 7 (2 pcs. pre-installed)
F. Spacer 22 mm.....	Qty 1

# INSTALLATION PROCEDURE

\*If equipped, remove factory skid plate or any other aftermarket skid plate.

\*Before installation: Remove bolts M10x30 (item C) and flat washers M10 (item E), which ship pre-installed in crossmember (item 2) and transfer case skid plate (item 1). Set aside to reuse later on.

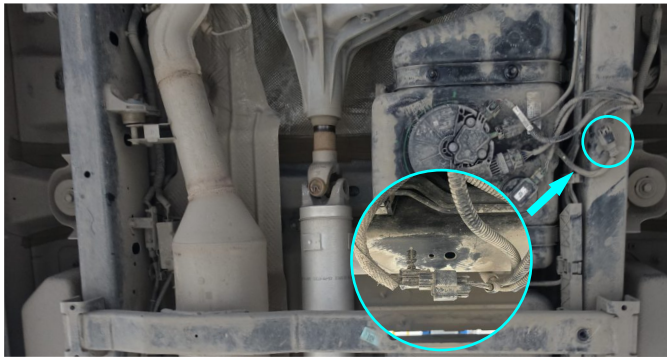

Fig. 1

1. Remove factory wiring from the frame (fig.1).

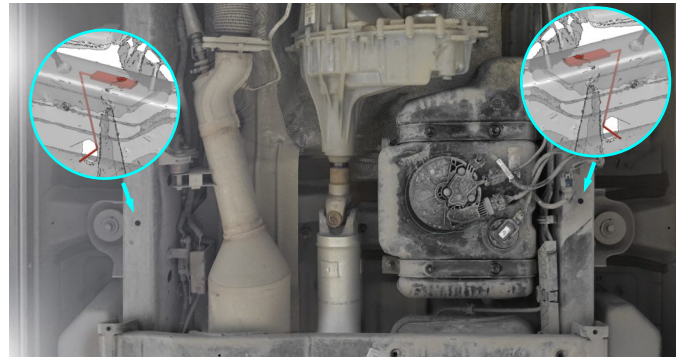

Fig. 2

2. Install insert nuts M10 with wire (item B) (fig.2).

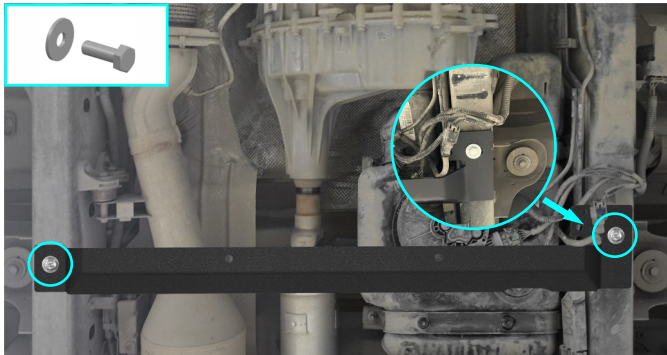

Fig. 3

3. Install crossmember (item 2) as shown in fig.3 and secure it using bolts M10x30 with flat washers M10 (items C, E).

\*Do not tighten yet.



Fig. 4

4. Install factory wiring to hole in crossmember (item 2) as shown in fig.4.

**If RIVAL transmission skid plate (2333.1505.1.6) is not installed (steps 5-7).**

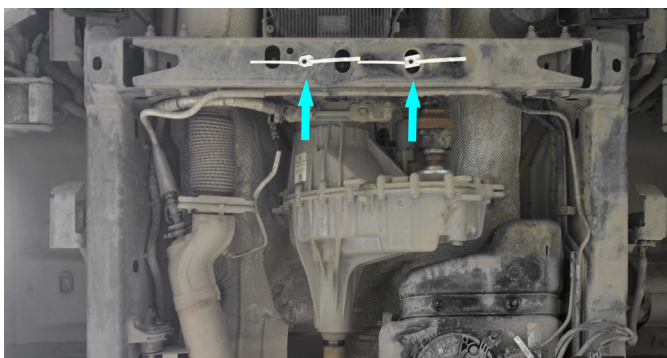

Fig. 5

5. Install insert nuts M10 (item A) as shown in fig.5.

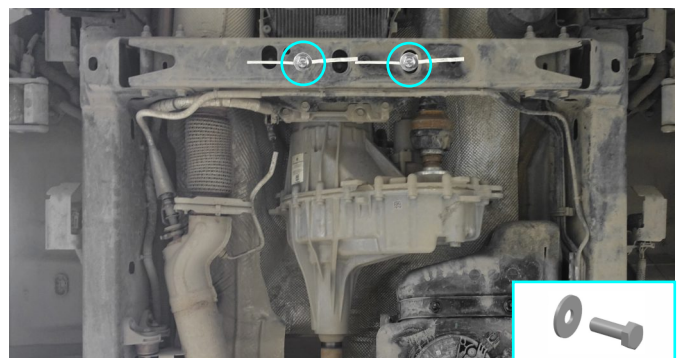

Fig. 6

6. Loosely insert supplied bolts M10x30 with flat washers M10 (items C, E) to insert nuts M10 (item A) (fig.6).

\*Do not tighten yet.

# INSTALLATION PROCEDURE



Fig. 7

7. Slide front part of transfer case skid plate (item 1) under previously installed bolts M10x30 from step 6 and secure it using bolts M10x30 with flat washers M10 (items C, E) as shown in fig.7.

**\*Do not tighten yet.**

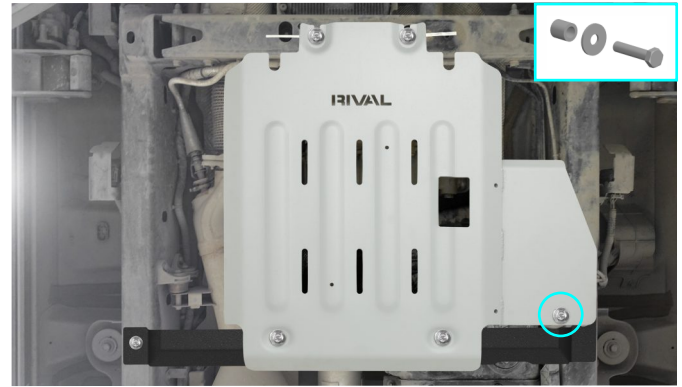

Fig. 8

8. Secure transfer case flap (item 1) using bolt M10x50, flat washer M10 and spacer 22 mm (items D, E, F) (fig.8).

**\*Once all bolts are inserted, tighten all previously installed hardware.**

**If RIVAL transmission skid plate (2333.1505.1.6) is installed (steps 9-10).**

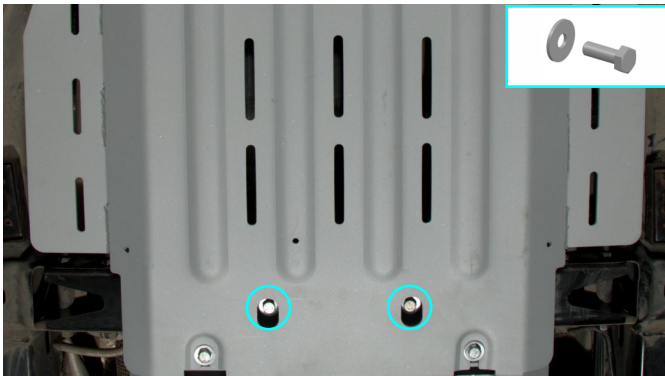

Fig. 9

9. Loosely insert supplied bolts M10x30 with flat washers M10 (items C, E) to rear bracket of RIVAL transmission skid plate (fig.9).

**\*Do not tighten yet.**

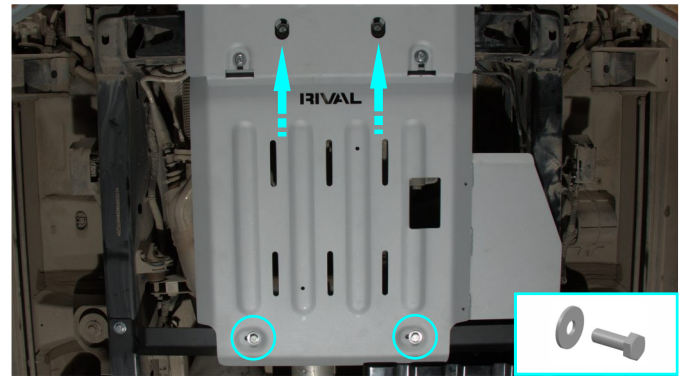

Fig. 10

10. Slide front part of transfer case skid plate (item 1) under previously installed bolts M10x30 from step 9 and secure it using bolts M10x30 with flat washers M10 (items C, E) as shown in fig.10.

**\*Do not tighten yet.**

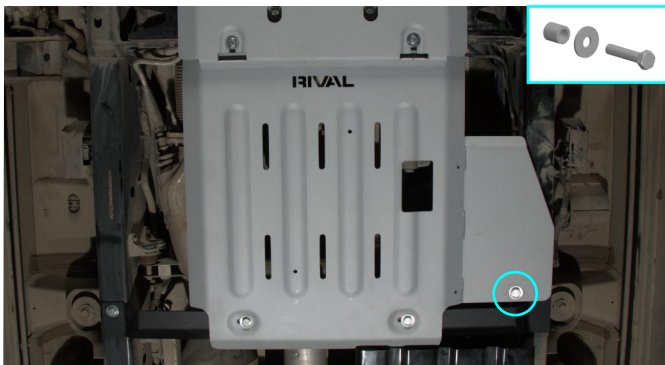

Fig. 11

11. Secure transfer case flap (item 1) using bolt M10x50, flat washer M10 and spacer 22 mm (items D, E, F) (fig.11).

**\*Once all bolts are inserted, tighten all previously installed hardware.**

# INSTALLATION PROCEDURE

---

Before operating a vehicle fitted with RIVAL Skid Plate:

- make sure all fittings are tightened;
- ensure the integrity of the structure and its components.

