

**EN**

**UNDERBODY ARMOUR INSTALLATION MANUAL  
(MUFFLER)**

**DE**

**MONTAGEANLEITUNG FÜR UNTERBODENSCHUTZSYSTEM  
(SCHALLDAMPER)**

**RU**

**ИНСТРУКЦИЯ ПО УСТАНОВКЕ КОМПЛЕКТА ЗАЩИТ  
(ГЛУШИТЕЛЯ)**



**Underbody Armour for:**

**Jeep Wrangler JL (2018-)**

111.2750.1 333.2750.1 333.2750.1.6  
2111.2750.1 2333.2750.1 2333.2750.1.6

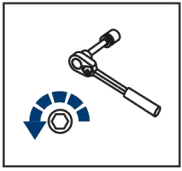

EN Regular fasteners  
DE Originale montageteile  
RU Штатный крепеж

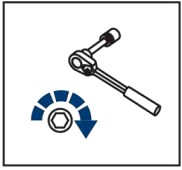

EN Regular fasteners  
DE Originale montageteile  
RU Штатный крепеж

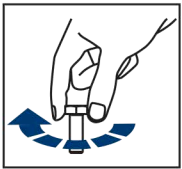

EN Screw a several turns  
DE Für wenigen Umdrehungen befestigen  
RU Вкрутить на несколько оборотов



EN Loosen bolts  
DE Bolzen lockern  
RU Выкрутить на несколько оборотов

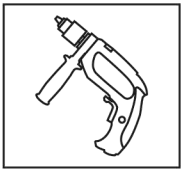

EN Drill  
DE Bohrer  
RU Дрель

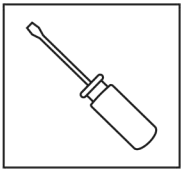

EN Screwdriver  
DE Schraubenzieher  
RU Отвертка

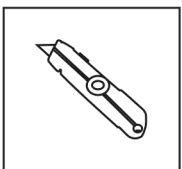

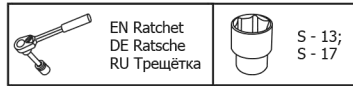

EN Office Knife  
DE Büromesser  
RU Канцелярский нож

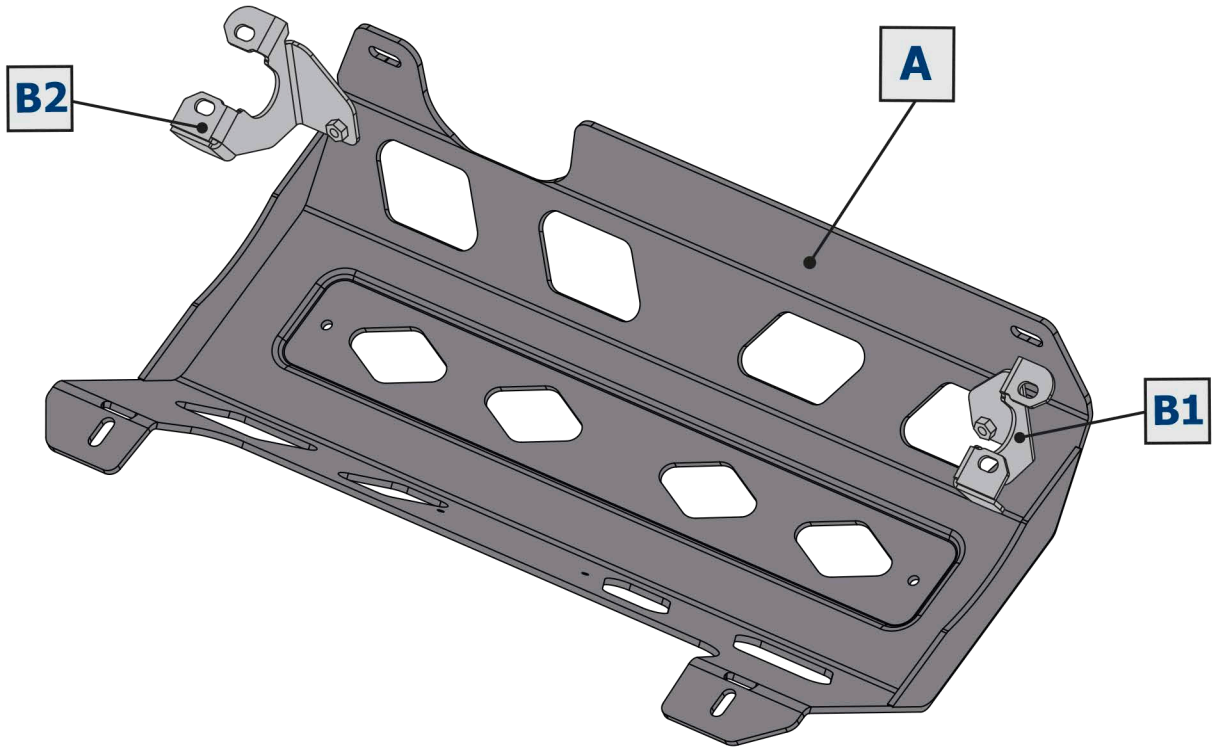

EN Office Knife  
DE Büromesser  
RU Канцелярский нож

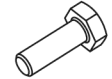

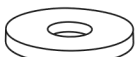
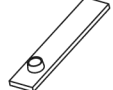
<p><b>1</b></p>  <p>M10x25 x4</p>	<p><b>2</b></p>  <p>Ø10 x4</p>	<p><b>3</b></p>  <p>Ø10 x4</p>	<p><b>4</b></p>  <p>M10 x2</p>
--	---	---	---

