

PRODUCT: TRANSMISSION SKID PLATE

APPLICATION: NISSAN PATROL Y61 SAFARI (2005-PRESENT)

PART NO: 2333.4116.2.6 / 2111.4116.2.3

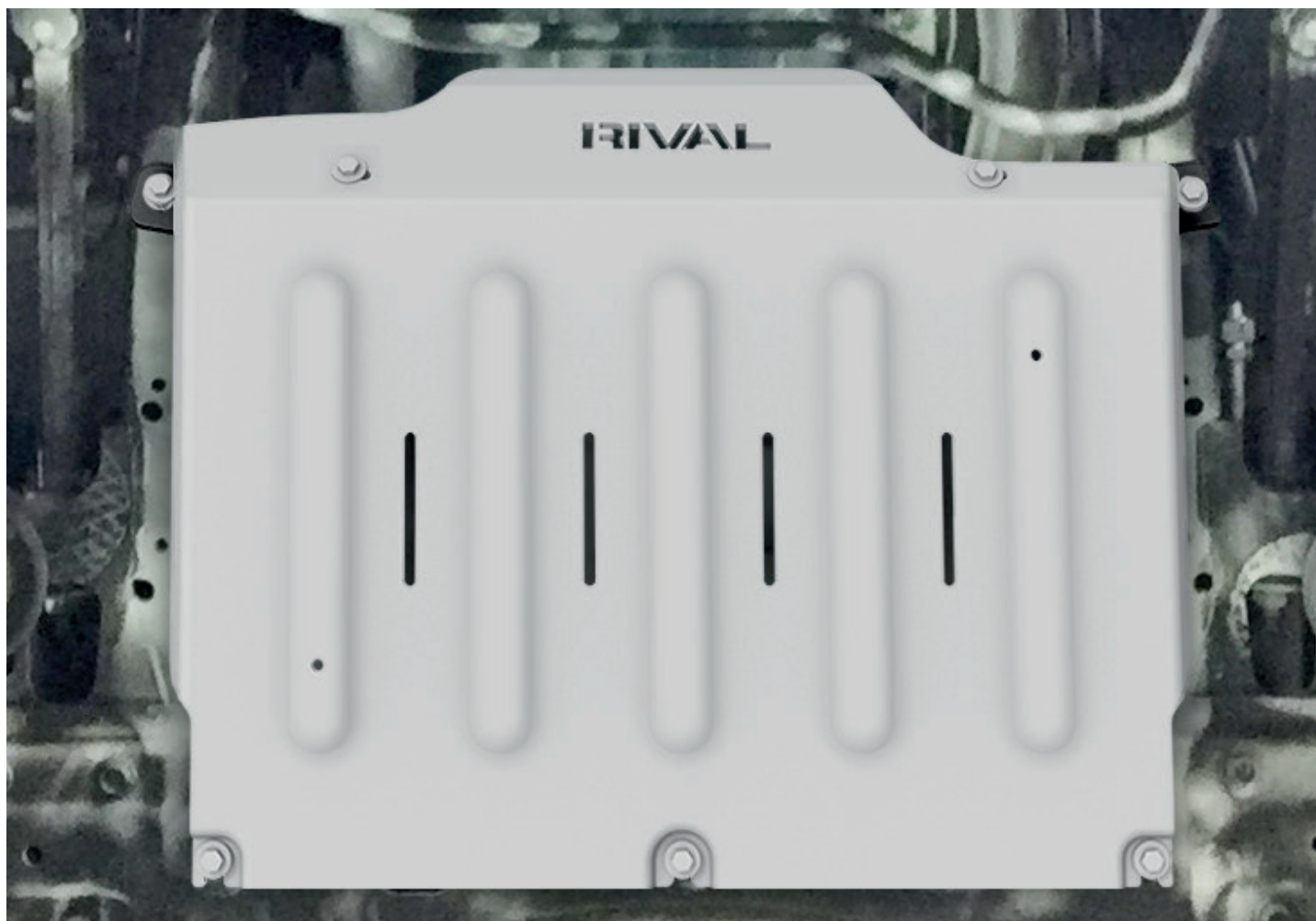

CAUTION!

To reduce the risk of serious injury or damage to property: Before you start installing and using this product, read the full instructions, pay special attention to the conditions of safe use and recommendations for installation! When installing or maintaining this product, it is necessary to use protective goggles. Check the integrity of the structure and the moment the fastening is tightened every 250 miles (400 kms) of mileage. Do not use this product if there is damage to the structure or fasteners!

NOTICE

Skid plate is an additional protection, but it can not guarantee to protect against all possible damage in collisions. When driving, be careful of objects and terrain that may damage sensitive parts of the vehicle.

TRANSMISSION SKID PLATE

RIVAL

Part number: 2333.4116.2.6 / 2111.4116.2.3

Suited to vehicle: Nissan Patrol Y61 Safari V-4.8 (2005-Present),
V-3.0d (2005-2010); MT

Material: Aluminum / Steel



SAFETY NOTICE

- * The RIVAL skid plate is designed to complement the use and design of the specified vehicle under conditions specified by the vehicle manufacturer.
- * While driving the vehicle at any speed, collision with any other vehicle, animal or object must always be avoided.
- * Following any collision with any other vehicle, animal or object, the RIVAL skid plate and the vehicle must be inspected by a specialized or suitably qualified vehicle repairer for possible damage to the components and assemblies in order to confirm suitability for further use of the vehicle.
- * It is strongly recommended that you do not operate a vehicle with a damaged skid plate or its components. In the case of damage, please contact the nearest RIVAL dealer. Vehicle, or where the skid plate has been damaged, is extremely dangerous and must be avoided at all cost.

INSTALLATION NOTICE

- * The RIVAL skid plate must be mounted and affixed to the vehicle according to this installation manual.
- * Personal safety during the installation process must be adhered to at all times.
- * Do not install this skid plate on vehicle models other than those allowed in this manual.
- * Estimated time for installation: 1 hour.

REQUIRED TOOLS

- * Basic tool kit
- * Torque wrench

TORQUE SETTING

- * M8 - 24 N·m (17.7 lb/ft)

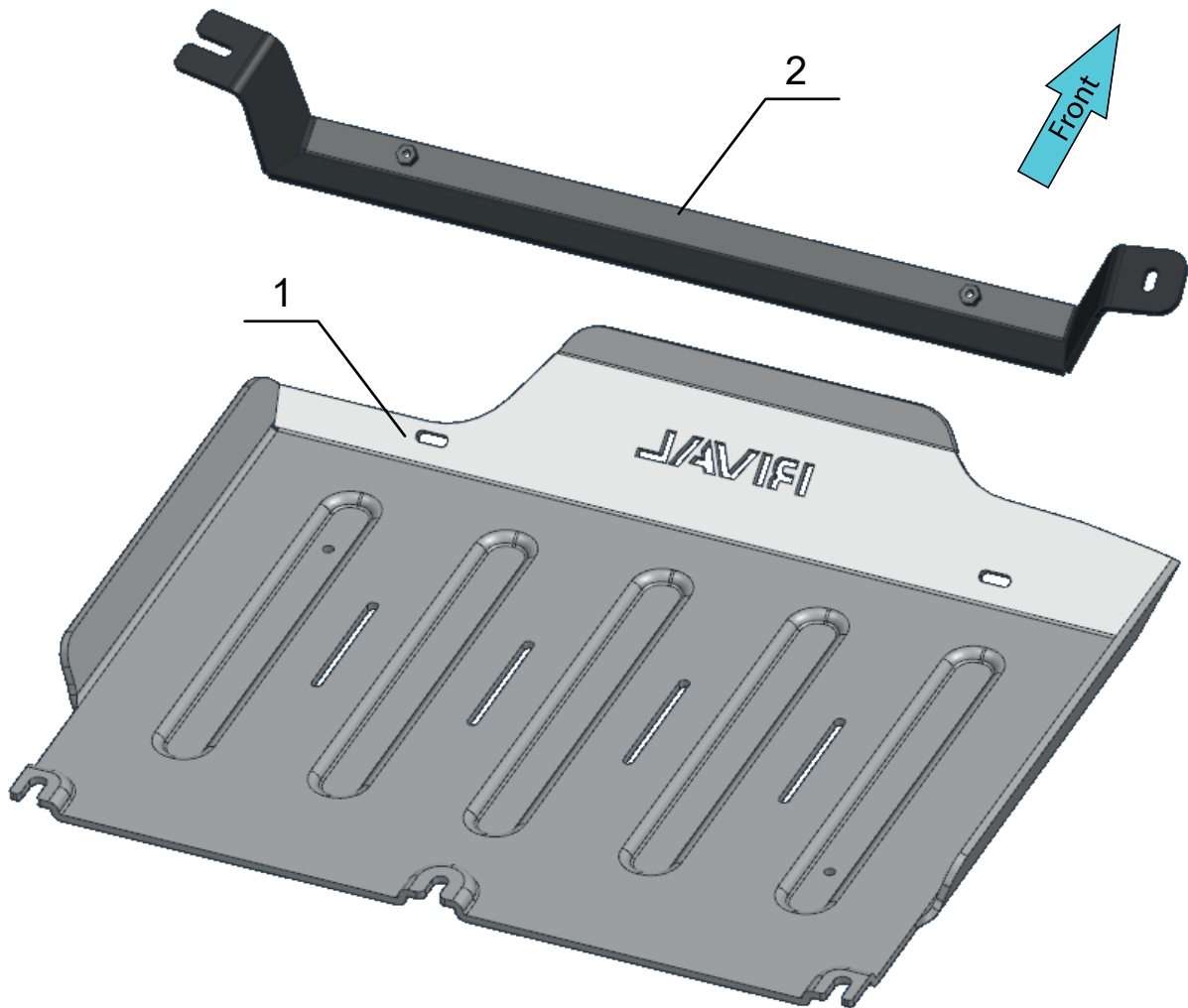

- 1. Skid plate.....Qty 1
- 2. Mounting bracket.....Qty 1

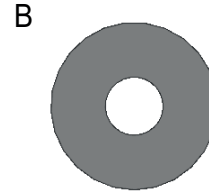
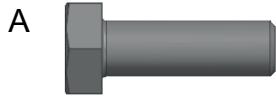

- A. Bolt M8x1.25x25.....Qty 7
- B. Washer M8.....Qty 7
- C. Insert nut M8x1.25 with wire.....Qty 1

*If equipped, remove any other aftermarket skid plate.

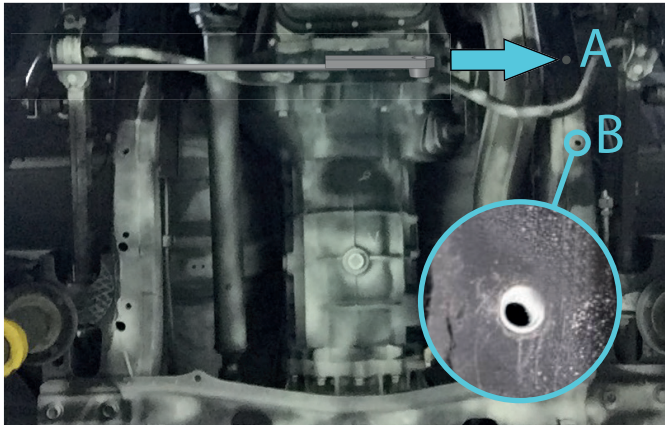

Fig. 1

1. Install insert nut M8x1.25 with wire (item C) into hole B through hole A (fig.1).

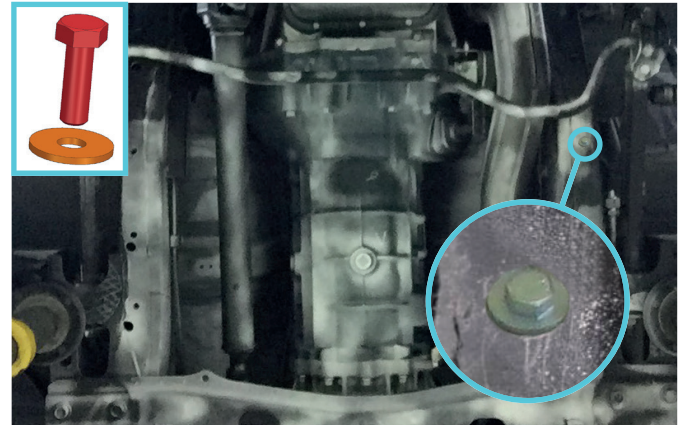

Fig. 2

2. Loosely insert supplied bolt M8x1.25x25 with washer M8 (items A, B) into insert nut M8x1.25 from step 1 as shown in fig. 2. ***Do not tighten yet.**

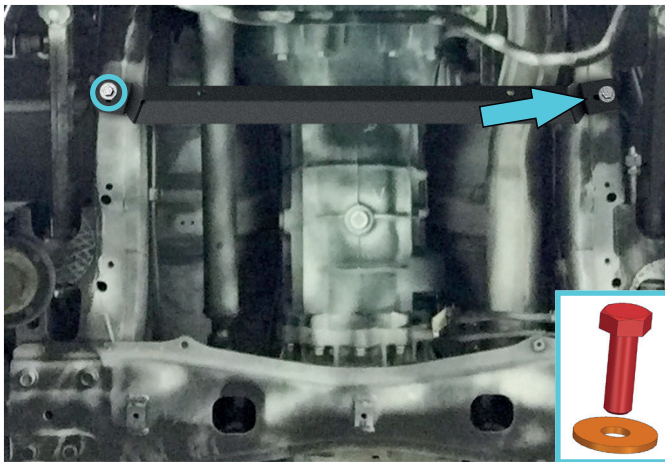

Fig. 3

3. Slide the left part of mounting bracket (item 2) on previously installed bolt M8x1.25x25 from step 2. Secure the right part of mounting bracket using bolt M8x1.25x25 with washer M8 (items A, B) as shown in fig. 3. ***Do not tighten yet.**

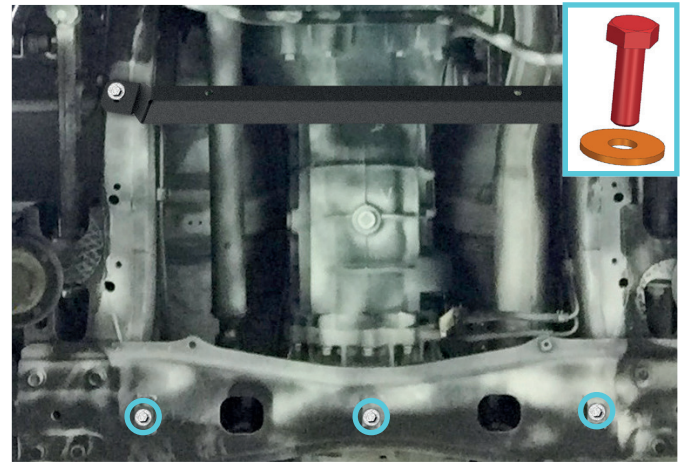

Fig. 4

4. Loosely insert supplied bolts M8x1.25x25 with washers M8 (items A,B) as shown in fig. 4. ***Do not tighten yet.**

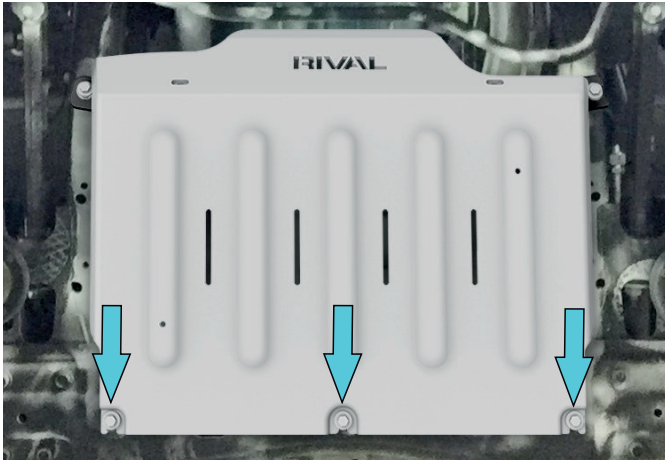

Fig. 5

5. Slide the rear part of skid plate (item 1) on previously installed bolts from step 4 as shown in fig. 5.

***Do not tighten yet.**

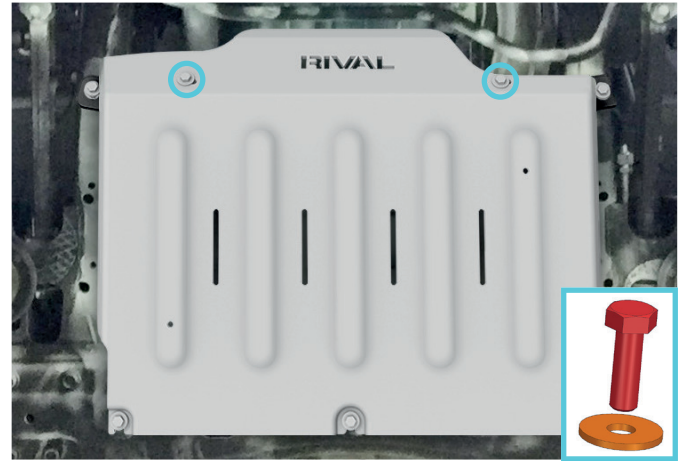

Fig. 6

6. Secure the front part of skid plate to pre-installed mounting bracket using bolts M8x1.25x25 with washers M8 (items A, B) as shown in fig.6.

***Once all bolts are inserted, check skid plate alignment and tighten all previously installed hardware.**

Before operating a vehicle fitted with RIVAL Skid Plate:

- make sure all fittings are tightened;
- ensure the integrity of the structure and its components.

