

INSTALLATION MANUAL

PRODUCT: ALUMINUM ENGINE SKID PLATE

APPLICATION: INEOS GRENADIER (2023-PRESENT)

PART NO: 2333.4501.1.6

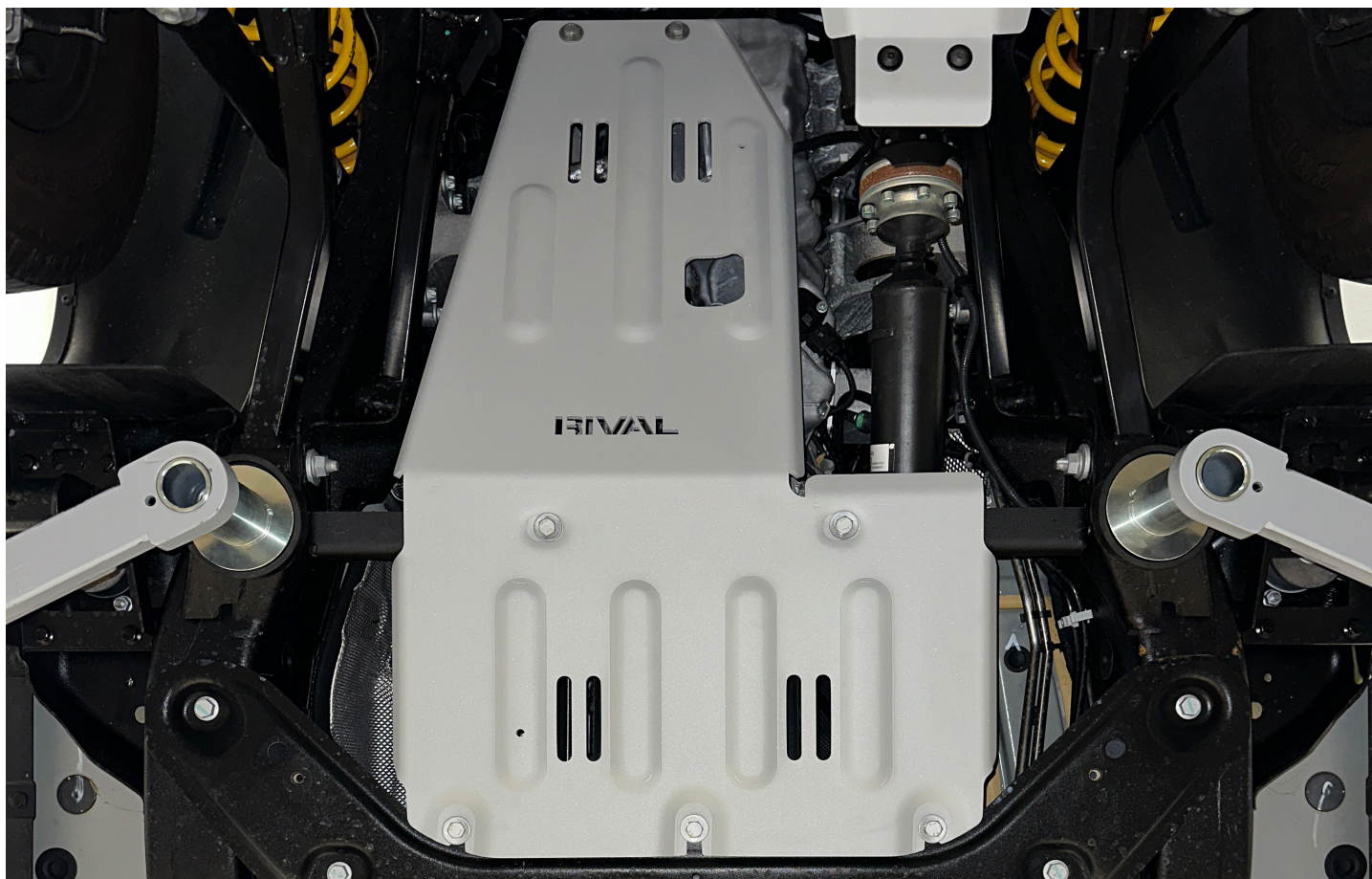

CAUTION!

To reduce the risk of serious injury or damage to property: Before you start installing and using this product, read the full instructions, pay special attention to the conditions of safe use and recommendations for installation! When installing or maintaining this product, it is necessary to use protective goggles. Check the integrity of the structure and the moment the fastening is tightened every 250 miles (400 kms) of mileage. Do not use this product if there is damage to the structure or fasteners!

NOTICE

Skid plate is an additional protection, but it can not guarantee to protect against all possible damage in collisions. When driving, be careful of objects and terrain that may damage sensitive parts of the vehicle.

ENGINE SKID PLATE

Part number 2333.4501.1.6

Suited to vehicle: INEOS GRENADIER (2023-Present), 3.0, 3.0D

Material: Aluminum, steel



SAFETY NOTICE

- * The RIVAL skid plate is designed to complement the use and design of the specified vehicle under conditions specified by the vehicle manufacturer.
- * While driving the vehicle at any speed, collision with any other vehicle, animal or object must always be avoided.
- * Following any collision with any other vehicle, animal or object, the RIVAL skid plate and the vehicle must be inspected by a specialized or suitably qualified vehicle repairer for possible damage to the components and assemblies in order to confirm suitability for further use of the vehicle.
- * It is strongly recommended that you do not operate a vehicle with a damaged skid plate or its components. In the case of damage, please contact the nearest RIVAL dealer. Vehicle, or where the skid plate has been damaged, is extremely dangerous and must be avoided at all cost.

INSTALLATION NOTICE

- * The RIVAL skid plate must be mounted and affixed to the vehicle according to this installation manual.
- * Personal safety during the installation process must be adhered to at all times.
- * Do not install this skid plate on vehicle models other than those allowed in this manual.
- * Estimated time for installation: 1 hour.

REQUIRED TOOLS

- * Basic tool kit
- * Torque wrench

TORQUE SETTING

M10 - 47 H·m (34.7 lb/ft)

PARTS LISTING

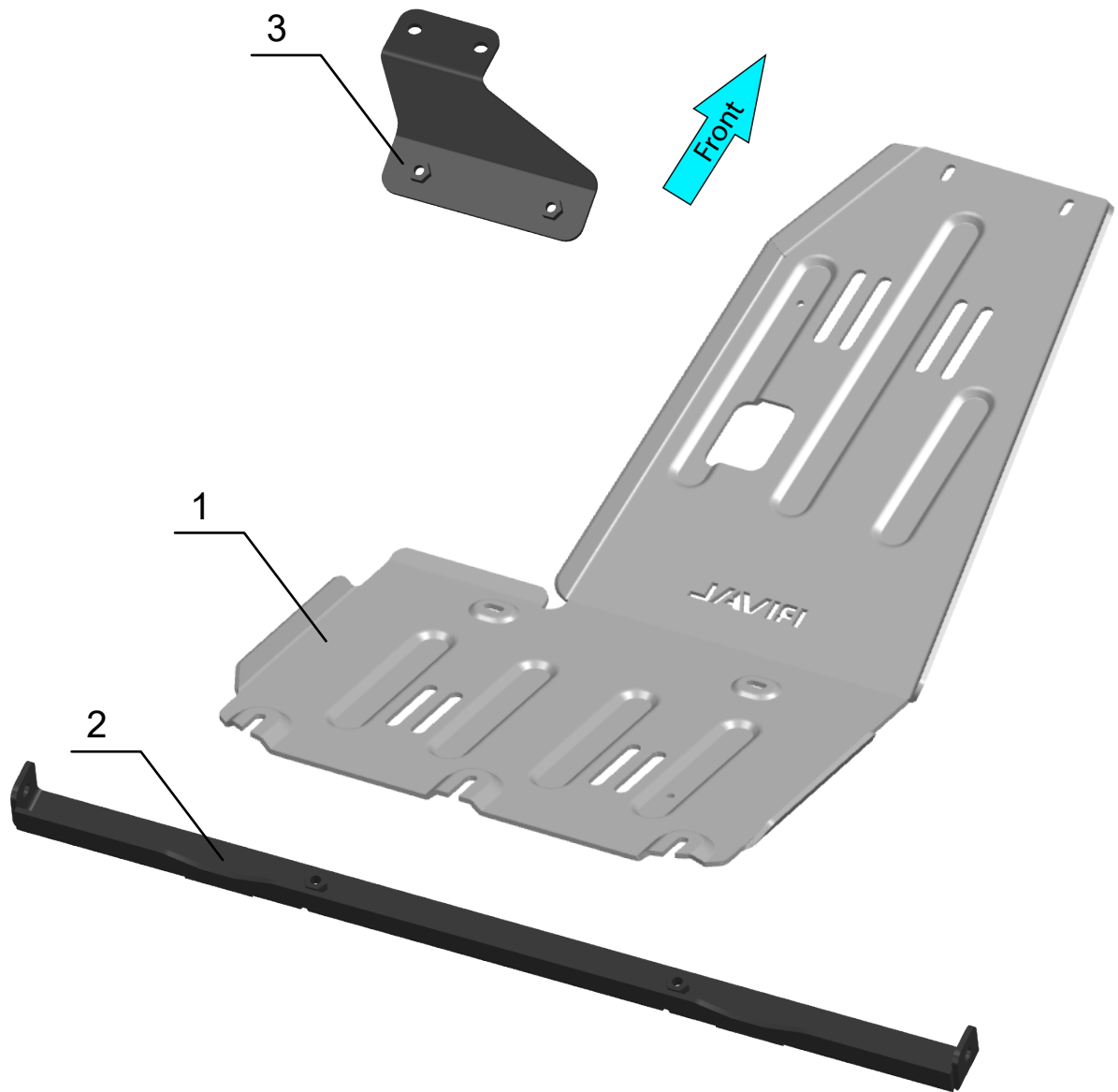

- 1. Engine skid plate.....Qty 1
- 2. Crossmember.....Qty 1
- 3. Bracket.....Qty 1

PARTS LISTING

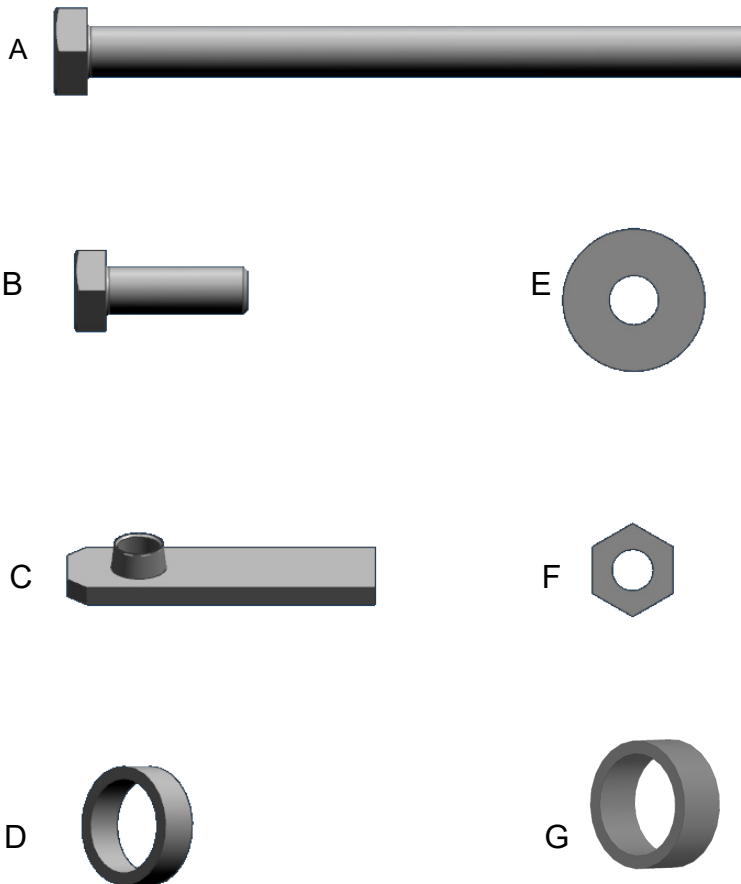

A. Bolt M10x150.....	Qty 2
B. Bolt M10x30.....	Qty 9
C. Insert nut M10.....	Qty 3
D. Spacer 8mm/0.31”.....	Qty 2
E. Washer M10.....	Qty 15
F. Nut M10.....	Qty 4
G. Spacer 10mm/0.39”.....	Qty 2

INSTALLATION PROCEDURE

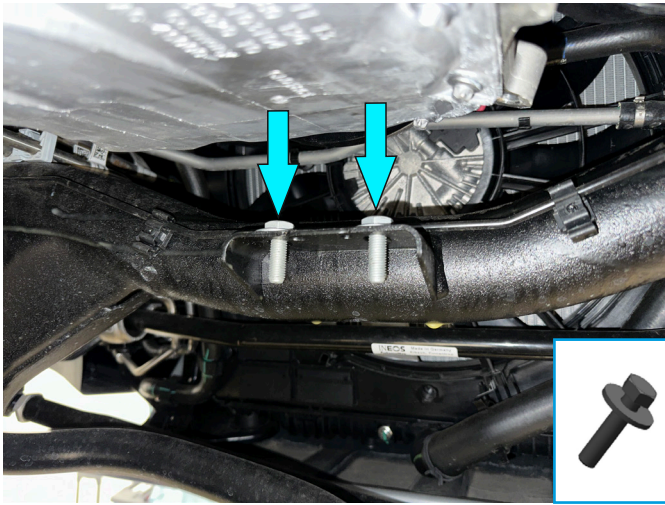

Fig. 1

1. Install bolts M10x30 with washers M10 (items B, E) into holes as shown in fig.1.

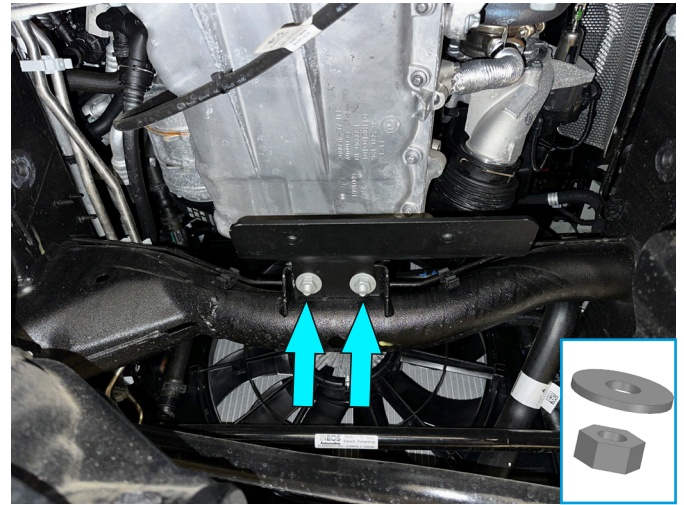

Fig. 2

2. Fix bracket (item 3) to insert bolts using nuts M10 and washers M10 (items F, E) (fig. 2).
***Do not tighten yet.**

Installation without RIVAL radius arm skid plate (2333.4503.1.6)

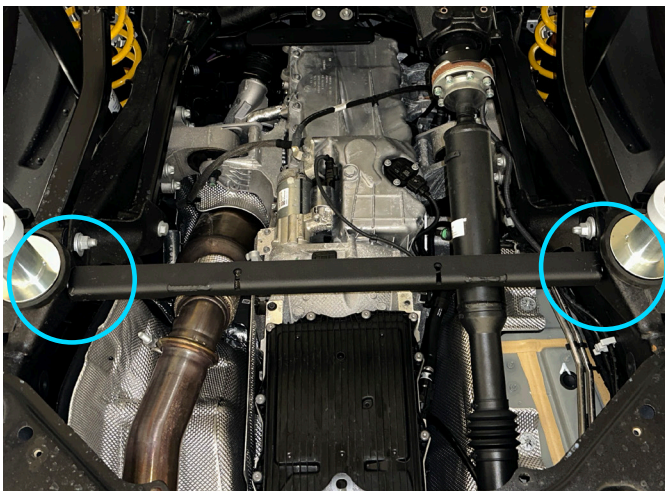

Fig. 3

3. Secure crossmember (item 2) using bolts M10x150 (item A), washers M10 (item E), spacers (items D or G), nuts M10 (item F) as shown in fig. 3 and 4.

***Do not tighten yet.**

****Proceed to step 5**

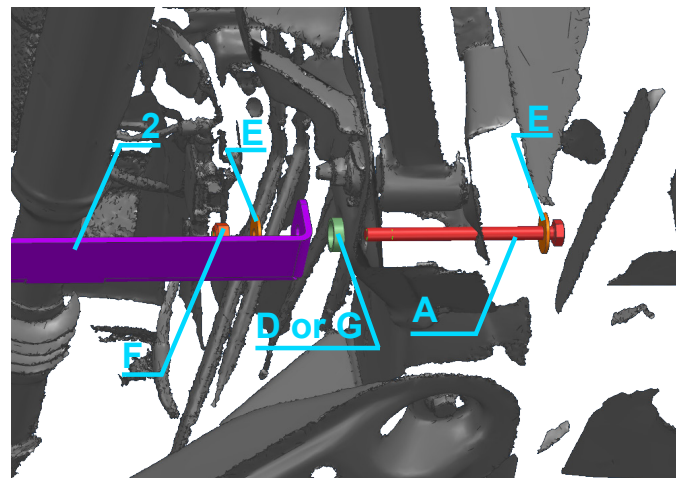

Fig. 4

INSTALLATION PROCEDURE

Installation with RIVAL radius arm skid plate (2333.4503.1.6)

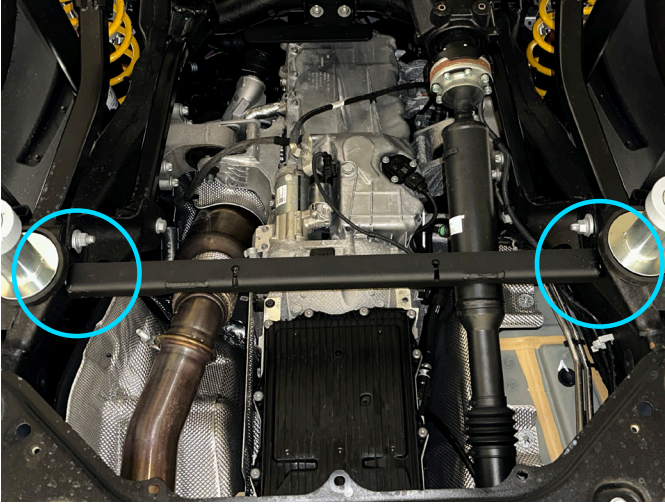

Fig. 5

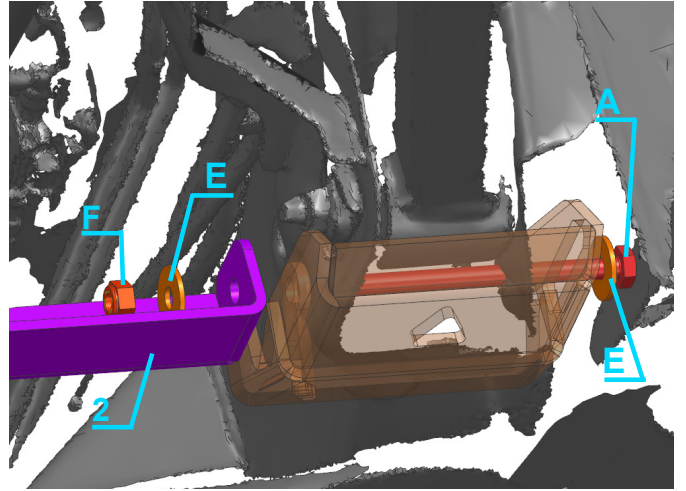

Fig. 6

4. Slide the crossmember (item 2) and slightly screw it on the left side of the vehicle with the radius arm skid plate 2333.4503.1.6 using bolts M10x150, washers M10 and nuts M10 (items A, E, F) as shown in fig 5 and fig. 6. Do the same on the right side of the vehicle.

***Do not tighten yet.**

****Proceed to step 5**

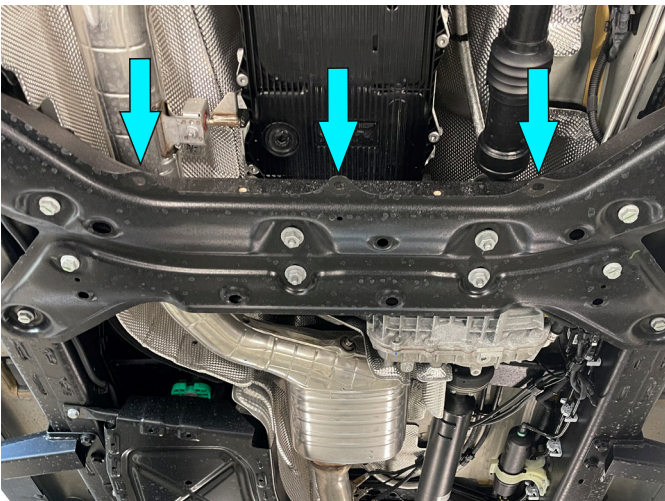

Fig. 7

5. Install insert nuts M10 (item C) into holes as shown in fig.7.

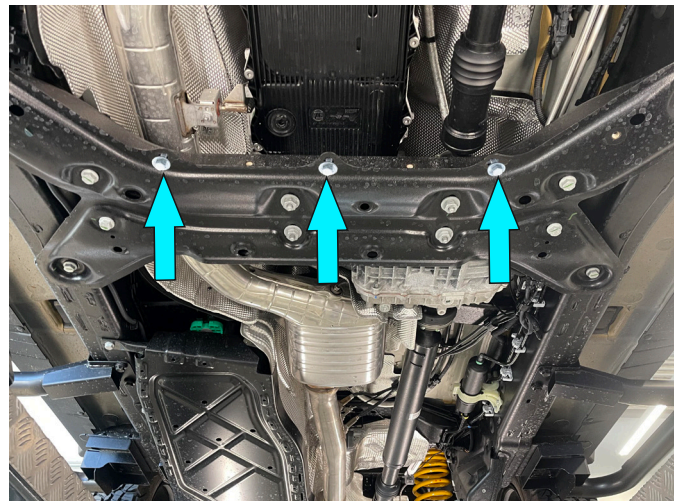

Fig. 8

6. Slightly screw bolts M10x30 with washers M10 (items B, E) into insert nuts M10 from step 5 (fig. 8).

***Do not tighten yet.**

INSTALLATION PROCEDURE

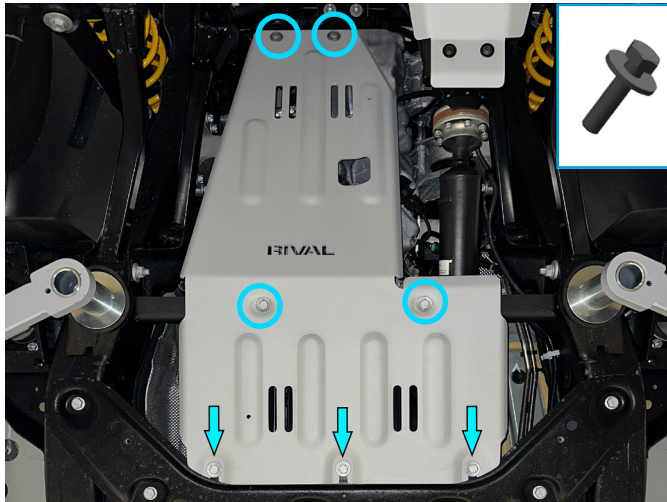

Fig. 9

7. Slide the rear part of engine skid plate (item 1) under previously installed bolts M10x30 from step 6. Secure skid plate to bracket and crossmember using bolts M10x30 and washers M10 (items B, E) (Fig. 9).

***Once all bolts are inserted, check skid plate alignment and tighten all previously installed hardware.**

INSTALLATION PROCEDURE

Before operating a vehicle fitted with RIVAL Skid Plate:

- make sure all fittings are tightened;
- ensure the integrity of the structure and its components.

