

INSTALLATION MANUAL

PRODUCT: RADIATOR SKID PLATE

APPLICATION: DODGE RAM 1500 (2018-Present)
DODGE RAM 1500 TRX (2021-Present)

PART NO: 2333.1502.1.6



CAUTION!

To reduce the risk of serious injury or damage to property: Before you start installing and using this product, read the full instructions, pay special attention to the conditions of safe use and recommendations for installation! When installing or maintaining this product, it is necessary to use protective goggles. Check the integrity of the structure and the moment the fastening is tightened every 250 miles (400 kms) of mileage. Do not use this product if there is damage to the structure or fasteners!

NOTICE

Skid plate is an additional protection, but it can not guarantee to protect against all possible damage in collisions. When driving, be careful of objects and terrain that may damage sensitive parts of the vehicle.

RADIATOR SKID PLATE

Part number: 2333.1502.1.6



Suited to vehicle: Dodge RAM 1500 V-5.7, 5.7 Hybrid, 3.0D; AT; 4WD (2018-Present);
(ONLY for vehicles without air dam)
Dodge RAM 1500 TRX V-6.2; AT; 4WD (2021-Present)

Material: Aluminum



SAFETY NOTICE

- * The RIVAL skid plate is designed to complement the use and design of the specified vehicle under conditions specified by the vehicle manufacturer.
- * While driving the vehicle at any speed, collision with any other vehicle, animal or object must always be avoided.
- * Following any collision with any other vehicle, animal or object, the RIVAL skid plate and the vehicle must be inspected by a specialized or suitably qualified vehicle repairer for possible damage to the components and assemblies in order to confirm suitability for further use of the vehicle.
- * It is strongly recommended that you do not operate a vehicle with a damaged skid plate or its components. In the case of damage, please contact the nearest RIVAL dealer. Vehicle, or where the skid plate has been damaged, is extremely dangerous and must be avoided at all cost.

INSTALLATION NOTICE

- * The RIVAL skid plate must be mounted and affixed to the vehicle according to this installation manual.
- * Personal safety during the installation process must be adhered to at all times.
- * Do not install this skid plate on vehicle models other than those allowed in this manual.
- * Estimated time for installation: 1 hour.

REQUIRED TOOLS

- * Basic tool kit
- * Torque wrench

TORQUE SETTING

- * M8 - 24 N·m (17.7 lb/ft)
- * M10 - 47 N·m (34.7 lb/ft)

PARTS LISTING

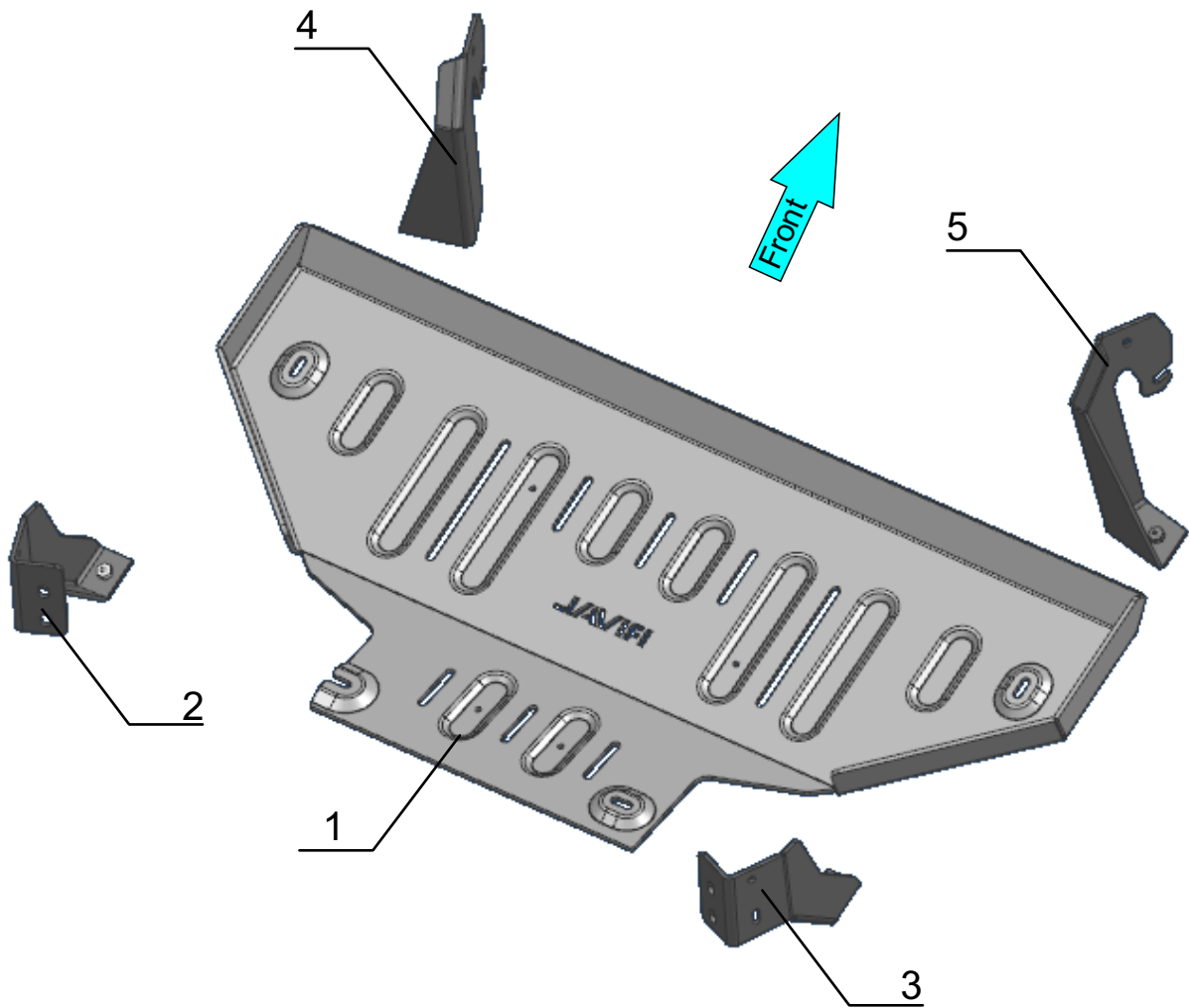

- 1. Radiator skid plate.....Qty 1
- 2. Left bracket.....Qty 1
- 3. Right bracket.....Qty 1
- 4. Left bracket for RAM 1500 TRX.....Qty 1
- 5. Right bracket for RAM 1500 TRX.....Qty 1

PARTS LISTING

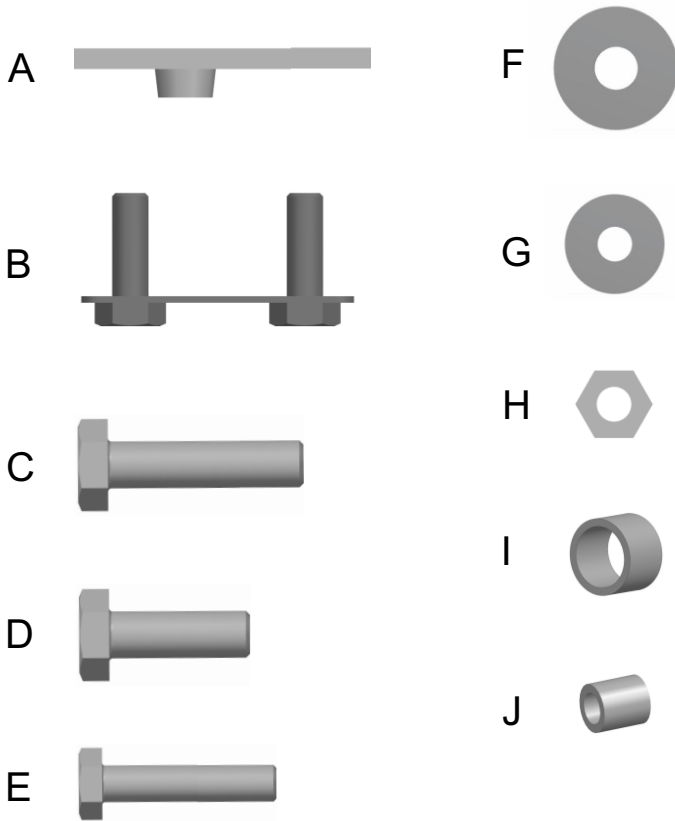

A. Insert nut M10x65x20.....	Qty 1
B. Insert nut M10.....	Qty 2
C. Bolt M10x50.....	Qty 2
D. Bolt M10x30.....	Qty 2
E. Bolt M8x40.....	Qty 4
F. Flat washer M10.....	Qty 8
G. Flat washer M8.....	Qty 4
H. Nut 10.....	Qty 4
I. Spacer 8 mm.....	Qty 2
J. Spacer 15 mm.....	Qty 2

INSTALLATION PROCEDURE

***If equipped, remove factory skid plate or any other aftermarket skid plate.**

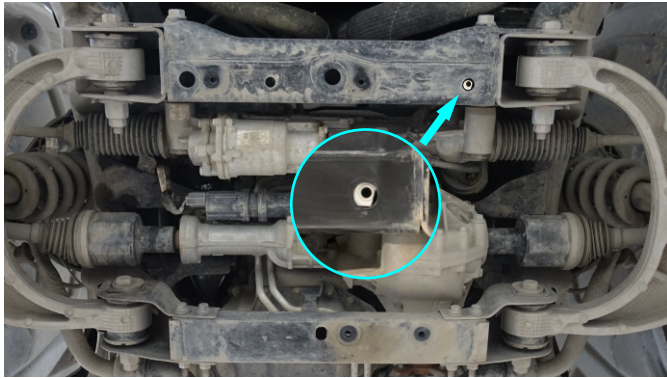

Fig. 1

1. Install insert nut M10x65x20 (item A) as shown in fig.1.

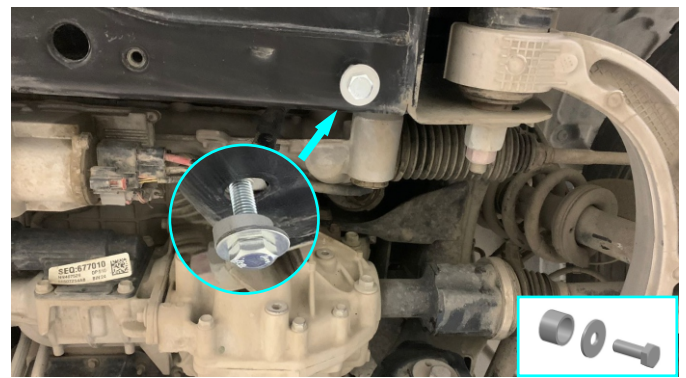

Fig. 2

2. Loosely insert supplied bolt M10x50 with flat washer M10 and spacer 8 mm (items C, F, I) on 2-3 turns to insert nut M10 from step 1 as shown in fig.2.

Installation procedure for Dodge RAM 1500 V-5.7, 5.7 Hybrid, 3.0D (steps 3-5).



Fig. 3

3. Remove two factory bolts on both sides of vehicle (fig.3).

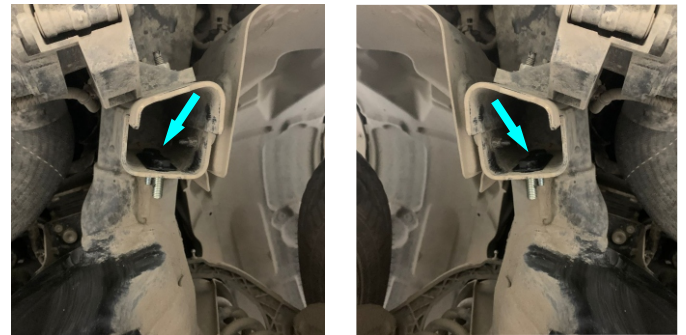

Fig. 4

4. Install insert nuts M10 (item B) on both sides as shown in fig.4.



Fig. 5

5. Install left bracket (item 2) and right bracket (item 3) as shown in fig.5. Secure them using flat washers M10, nuts M10 (items F, H) and insert nuts M10 from step 4.

***Tighten hardware after that.**

INSTALLATION PROCEDURE

Installation procedure for Dodge RAM 1500 TRX V-6.2 (steps 6-10).



Fig. 6

6. Remove one factory bolt on the left side of the vehicle as shown in fig.6.

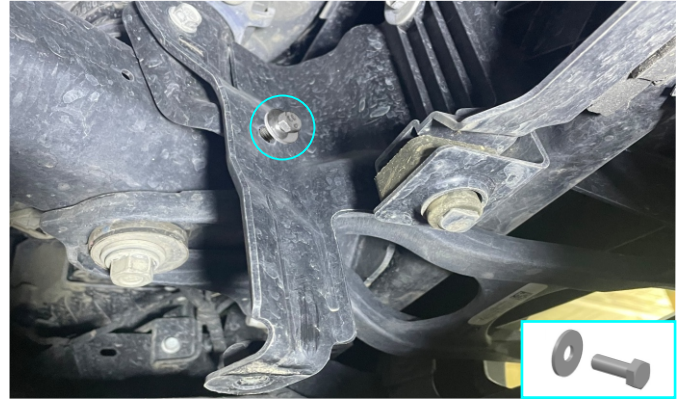

Fig. 7

7. Loosely insert supplied bolt M8x40 with flat washer M8 (items E, G) on 2-3 turns to factory radiator bracket as shown in fig.7.



Fig. 8

8. Remove 2nd factory bolt on the left side of the vehicle as shown in fig.8.

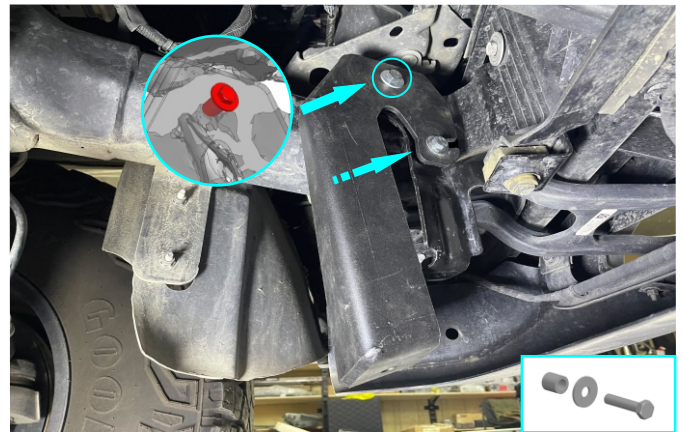

Fig. 9

9. Install left bracket for RAM 1500 TRX (item 4) as shown in fig.9 and secure it using bolt M8x40, spacer 15 mm and flat washer M8 (items E, J, G).

***Tighten hardware after that.**

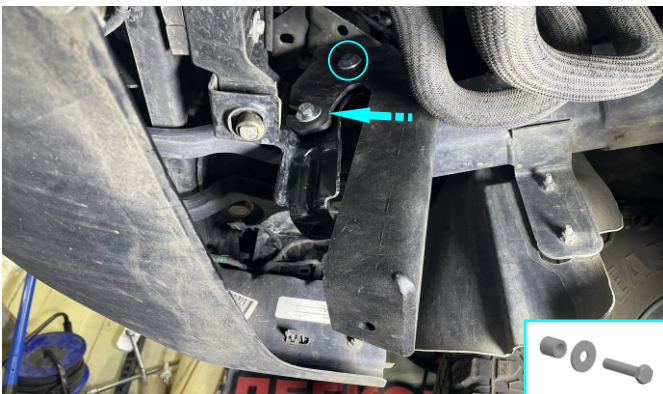

Fig. 10

10. Repeat the same steps 6-9 on the right side using right bracket for RAM 1500 TRX (item 5).

***Tighten hardware after that.**

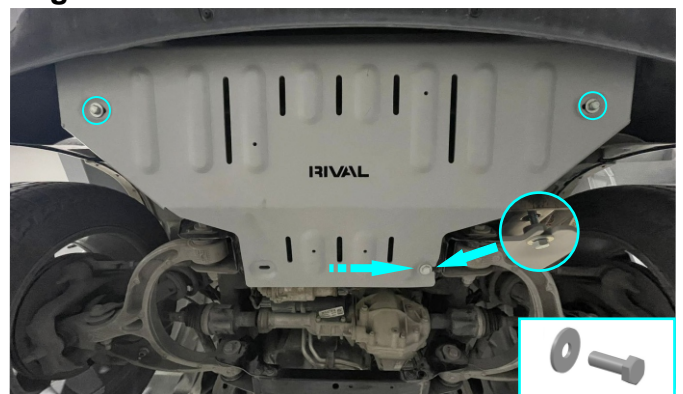

Fig. 11

11. Slide front part of radiator skid plate (item 1) under front bumper after that slide rear part of radiator skid plate (item 1) under previously installed bolt M10x50. Secure front part using bolts M10x30 with flat washers M10 (items D, F) as shown in fig.11.

***Do not tighten yet.**

INSTALLATION PROCEDURE

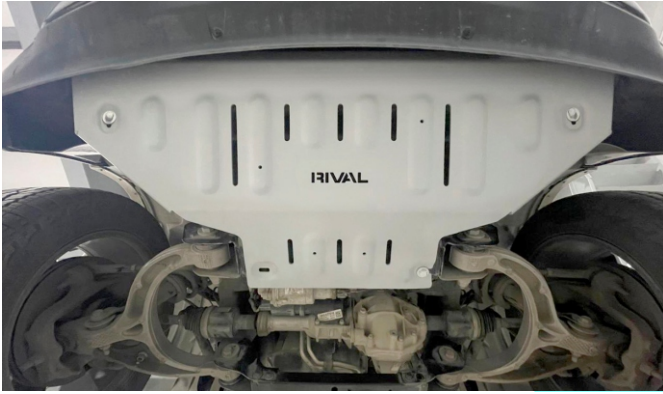

Fig. 12

12. Install remaining bolt M10x50 with flat washer M10 and spacer 8 mm (items C, F, I) into skid plate as shown in fig.12.

***Once all bolts are inserted, check skid plate alignment and tighten all previously.**

If the RIVAL engine skid plate (2333.1504.1.6) is installed (steps 13-14).



Fig. 13

13. Remove front bolts of engine skid plate (2333.1504.1.6). After that secure front part of radiator skid plate (item 1) using bolts M10x30 with flat washers M10 (items D, F) as shown in fig.13.

***Do not tighten yet.**

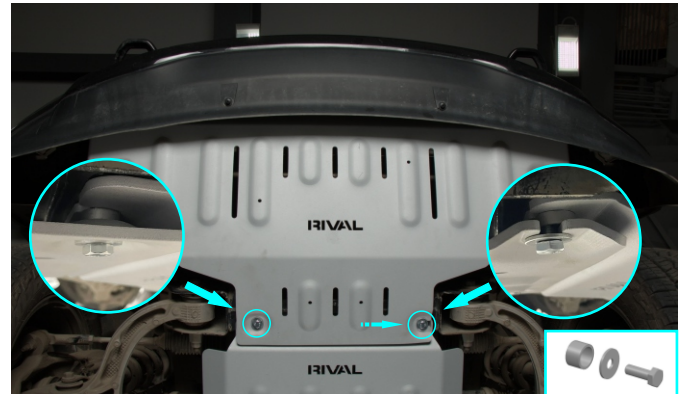

Fig. 14

14. Install bolts M10x50 with flat washers and spacers 8 mm (items C, F, I) into joint skid plates as shown in fig.14.

***Once all bolts are inserted, check skid plate alignment and tighten all previously installed hardware.**

INSTALLATION PROCEDURE

Before operating a vehicle fitted with RIVAL Skid Plate:

- make sure all fittings are tightened;
- ensure the integrity of the structure and its components.



INSTALLATION MANUAL

PRODUCT: ENGINE SKID PLATE

APPLICATION: DODGE RAM 1500 (2018-Present)
DODGE RAM 1500 TRX (2021-Present)

PART NO: 2333.1504.1.6



CAUTION!

To reduce the risk of serious injury or damage to property: Before you start installing and using this product, read the full instructions, pay special attention to the conditions of safe use and recommendations for installation! When installing or maintaining this product, it is necessary to use protective goggles. Check the integrity of the structure and the moment the fastening is tightened every 250 miles (400 kms) of mileage. Do not use this product if there is damage to the structure or fasteners!

NOTICE

Skid plate is an additional protection, but it can not guarantee to protect against all possible damage in collisions. When driving, be careful of objects and terrain that may damage sensitive parts of the vehicle.

ENGINE SKID PLATE

Part number: 2333.1504.1.6



Suited to vehicle: Dodge RAM 1500 V-5.7, 5.7 Hybrid, 3.0D; AT; 4WD (2018-Present);
Dodge RAM 1500 TRX V-6.2; AT; 4WD (2021-Present)

Material: Aluminum



SAFETY NOTICE

- * The RIVAL skid plate is designed to complement the use and design of the specified vehicle under conditions specified by the vehicle manufacturer.
- * While driving the vehicle at any speed, collision with any other vehicle, animal or object must always be avoided.
- * Following any collision with any other vehicle, animal or object, the RIVAL skid plate and the vehicle must be inspected by a specialized or suitably qualified vehicle repairer for possible damage to the components and assemblies in order to confirm suitability for further use of the vehicle.
- * It is strongly recommended that you do not operate a vehicle with a damaged skid plate or its components. In the case of damage, please contact the nearest RIVAL dealer. Vehicle, or where the skid plate has been damaged, is extremely dangerous and must be avoided at all cost.

INSTALLATION NOTICE

- * The RIVAL skid plate must be mounted and affixed to the vehicle according to this installation manual.
- * Personal safety during the installation process must be adhered to at all times.
- * Do not install this skid plate on vehicle models other than those allowed in this manual.
- * Estimated time for installation: 1 hour.

REQUIRED TOOLS

- * Basic tool kit
- * Torque wrench

TORQUE SETTING

- * M10 - 47 N·m (34.7 lb/ft)

PARTS LISTING

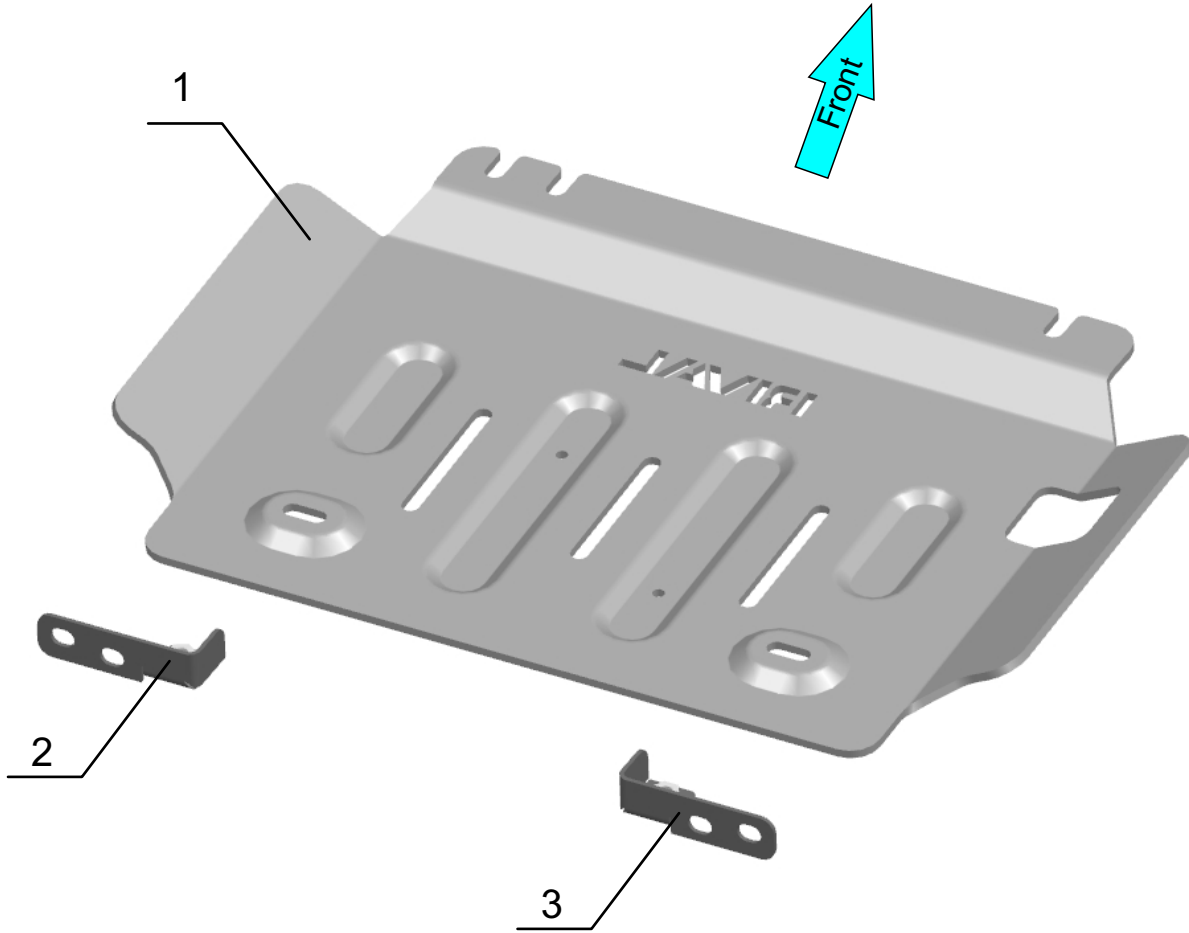

- 1. Engine skid plate.....Qty 1
- 2. Left bracket.....Qty 1
- 3. Right bracket.....Qty 1

PARTS LISTING

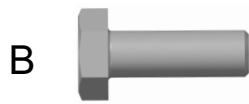

- A. Insert nut M10x65x20.....Qty 1
- B. Bolt M10x30.....Qty 4
- C. Flat washer M10.....Qty 4

INSTALLATION PROCEDURE

*If equipped, remove factory skid plate or any other aftermarket skid plate.

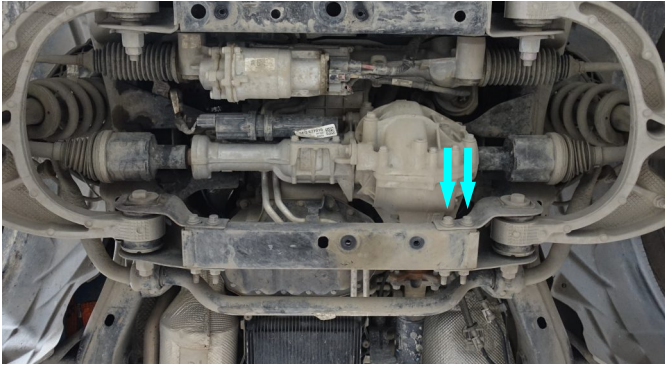

Fig. 1

1. Remove two factory bolts from the frame on the left side of the vehicle (fig.1).



Fig. 2

2. Install left bracket (item 2) as shown in fig.2 using factory bolts and nuts from step 1.
***Tighten hardware after that.**

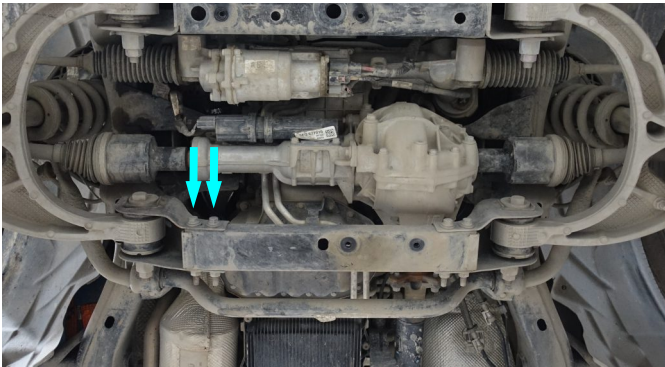

Fig. 3

3. Remove two factory bolts from car frame on the right side of the vehicle (fig.3).



Fig. 4

4. Install right bracket (item 3) as shown in fig.4 using factory bolts and nuts from step 3.
***Tighten hardware after that.**



Fig. 5

5. If you plan to install RIVAL Transmission skid plate (2333.1505.1.6), then also install left bracket (item 2) and right bracket (item 3) from RIVAL Transmission skid plate (2333.1505.1.6) (fig.5). After that secure them using factory bolts and nuts from steps 1 and 3.

INSTALLATION PROCEDURE

If the RIVAL radiator skid plate (2333.1502.1.6/2333.1503.1.6) is not installed (steps 6-8).

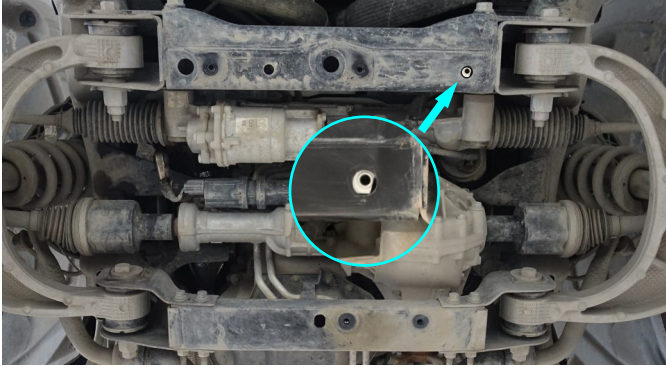

Fig. 6

6. Install insert nut M10x65x20 (item A) as shown in fig.6.

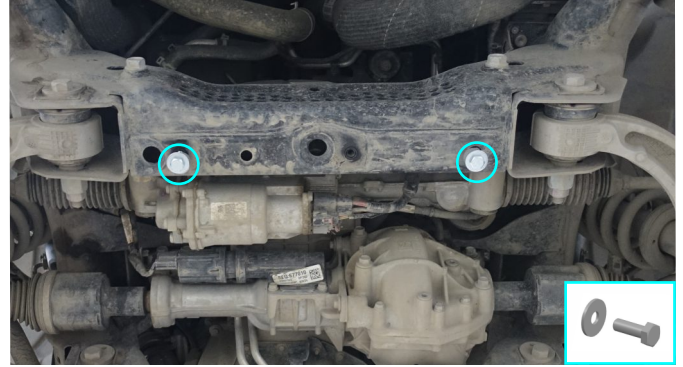

Fig. 7

7. Loosely insert supplied bolts M10x30 with flat washers M10 (items B, C) to insert nut M10x65x20 from step 6 and into factory threaded hole as shown in fig.7.

***Do not tighten yet.**



Fig. 8

8. Slide front part of engine skid plate (item 1) under previously installed bolts M10x30 from step 7 and secure it using bolts M10x30 and flat washers M10 (items B, C) (fig.8).

***Once all bolts are inserted, tighten all previously installed hardware.**

If the RIVAL radiator skid plate (2333.1502.1.6/2333.1503.1.6) is installed (steps 9-10).



Fig. 9

9. Loosen 4 bolts on RIVAL radiator skid plate (fig.9).



Fig. 10

10. Slide front part of engine skid plate (item 1) under RIVAL radiator skid plate as shown in fig.10. After that secure it using bolts M10x30 and flat washers M10 (items B, C).

***Once all bolts are inserted, tighten all previously installed hardware.**

INSTALLATION PROCEDURE

Installation procedure for RAM TRX with factory radiator skid plate (steps 11-12).



Fig. 11

11. Loosen four factory bolts (fig.11).



Fig. 12

12. Slide front part of engine skid plate under factory radiator skid plate as shown in fig.12. Next, secure it using bolts M10x30 and flat washers M10 (items B, C).

***Once all bolts are inserted, tighten all previously installed hardware.**

INSTALLATION PROCEDURE

Before operating a vehicle fitted with RIVAL Skid Plate:

- make sure all fittings are tightened;
- ensure the integrity of the structure and its components.



INSTALLATION MANUAL

PRODUCT: TRANSMISSION SKID PLATE

APPLICATION: DODGE RAM 1500 (2018-Present)
DODGE RAM 1500 TRX (2021-Present)

PART NO: 2333.1505.1.6



CAUTION!

To reduce the risk of serious injury or damage to property: Before you start installing and using this product, read the full instructions, pay special attention to the conditions of safe use and recommendations for installation! When installing or maintaining this product, it is necessary to use protective goggles. Check the integrity of the structure and the moment the fastening is tightened every 250 miles (400 kms) of mileage. Do not use this product if there is damage to the structure or fasteners!

NOTICE

Skid plate is an additional protection, but it can not guarantee to protect against all possible damage in collisions. When driving, be careful of objects and terrain that may damage sensitive parts of the vehicle.

TRANSMISSION SKID PLATE

Part number: 2333.1505.1.6



Suited to vehicle: Dodge RAM 1500 V-5.7, 5.7 Hybrid, 3.0D; AT; 4WD (2018-Present);
Dodge RAM 1500 TRX V-6.2; AT; 4WD (2021-Present)

Material: Aluminum



SAFETY NOTICE

- * The RIVAL skid plate is designed to complement the use and design of the specified vehicle under conditions specified by the vehicle manufacturer.
- * While driving the vehicle at any speed, collision with any other vehicle, animal or object must always be avoided.
- * Following any collision with any other vehicle, animal or object, the RIVAL skid plate and the vehicle must be inspected by a specialized or suitably qualified vehicle repairer for possible damage to the components and assemblies in order to confirm suitability for further use of the vehicle.
- * It is strongly recommended that you do not operate a vehicle with a damaged skid plate or its components. In the case of damage, please contact the nearest RIVAL dealer. Vehicle, or where the skid plate has been damaged, is extremely dangerous and must be avoided at all cost.
- * We recommend using a funnel when changing the oil to prevent spills and ensure a clean process.

INSTALLATION NOTICE

- * The RIVAL skid plate must be mounted and affixed to the vehicle according to this installation manual.
- * Personal safety during the installation process must be adhered to at all times.
- * Do not install this skid plate on vehicle models other than those allowed in this manual.
- * Estimated time for installation: 1 hour.

REQUIRED TOOLS

- * Basic tool kit
- * Torque wrench

TORQUE SETTING

- * M10 - 47 N·m (34.7 lb/ft)

PARTS LISTING

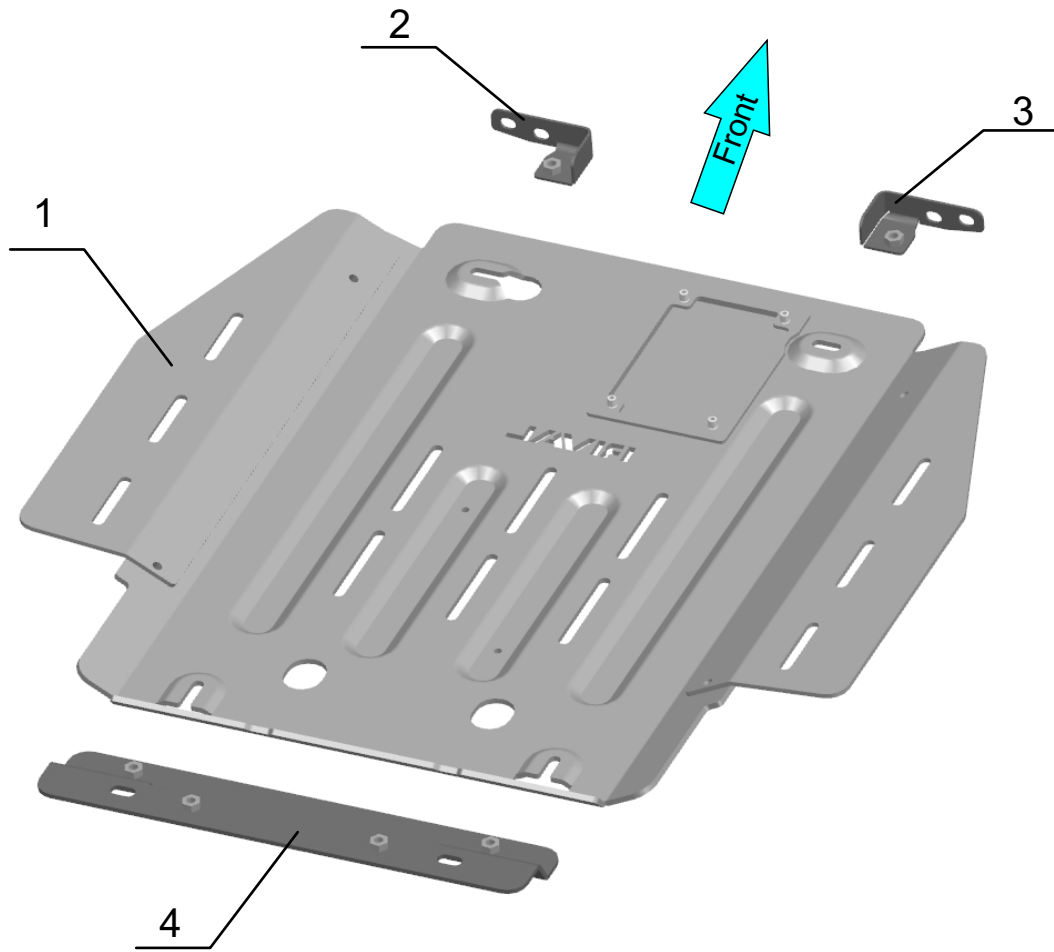

- 1. Transmission skid plate.....Qty 1
- 2. Left bracket.....Qty 1
- 3. Right bracket.....Qty 1
- 4. Rear bracket.....Qty 1

PARTS LISTING

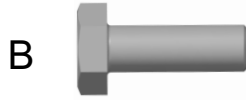

- A. Insert nut M10.....Qty 1
- B. Bolt M10x30.....Qty 6 (2 pcs. pre-installed)
- C. Flat washer M10.....Qty 6 (2 pcs. pre-installed)

SPARE PARTS

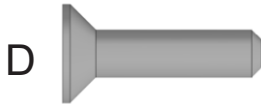

- D. Countersunk screw M6x20.....Qty 4

INSTALLATION PROCEDURE

*If equipped, remove factory skid plate or any other aftermarket skid plate.

*Before installation: Remove bolts M10x30 (item B) and flat washers M10 (item C), which ship pre-installed in rear bracket (item 4) and transmission skid plate (item 1). Set aside to reuse later on.

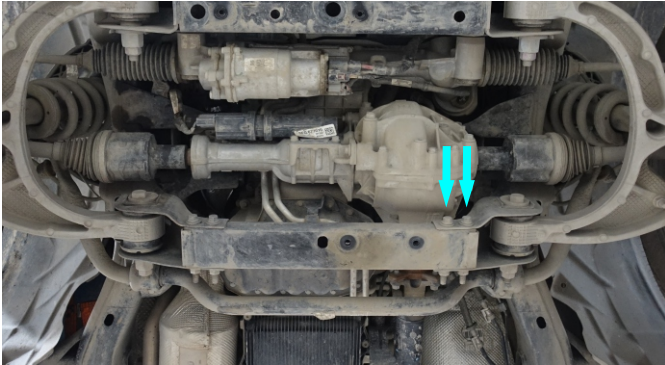

Fig. 1

1. Remove two factory bolts from the frame on the left side of the vehicle (fig.1).

*If you have installed RIVAL engine skid plate (2333.1504.1.6), skip steps 1-4.



Fig. 2

2. Install left bracket (item 2) as shown in fig.2 using factory bolts and nuts from step 1.

*Tighten hardware after that.

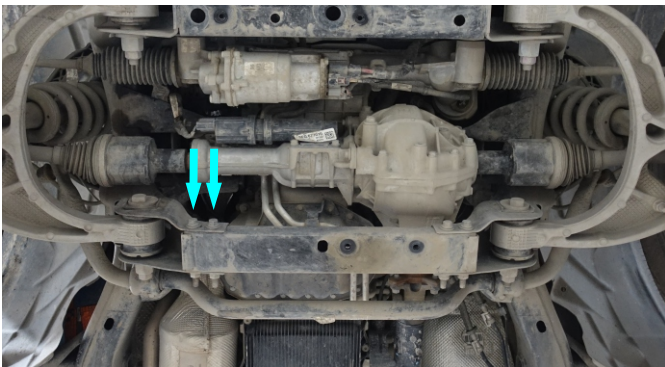

Fig. 3

3. Remove two factory bolts from the frame on the right side of the vehicle (fig.3).



Fig. 4

4. Install right bracket (item 3) as shown in fig.4 using factory bolts and nuts from step 3.

*Tighten hardware after that.



Fig. 5

5. Loosely insert supplied bolt M10x30 with flat washer M10 (items B, C) to right bracket (item 3) as shown in fig.5.



Fig. 6

6. Install insert nut 10 (item A) as shown in fig.6.

INSTALLATION PROCEDURE

Dodge RAM 1500 V-5.7, 5.7 Hybrid
Dodge RAM 1500 TRX V-6.2

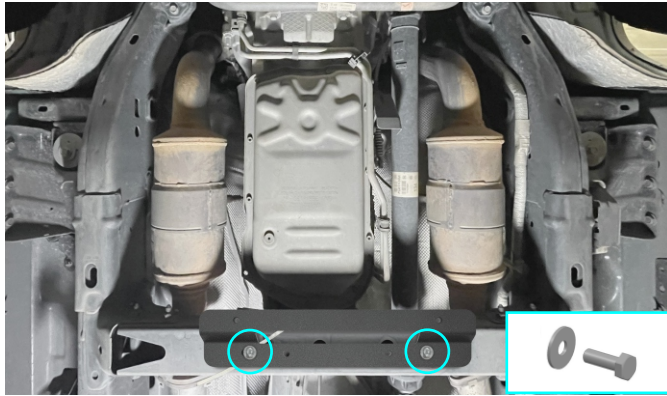

Fig. 7

Dodge RAM 1500 V-3.0D



Fig. 8

7. Install rear bracket (item 4) as shown in fig.7&8 using bolts M10x30 and flat washers M10 (items B, C).

***Tighten hardware after that.**



Fig. 9

8. Slide front part of transmission skid plate (item 1) under previously installed bolt M10x30 from step 5. After that secure transmission skid plate (item 1) using bolts M10x30 with flat washers M10 (items B, C) as shown in fig.9.

***Once all bolts are inserted, tighten all previously installed hardware.**

INSTALLATION PROCEDURE

Before operating a vehicle fitted with RIVAL Skid Plate:

- make sure all fittings are tightened;
- ensure the integrity of the structure and its components.



INSTALLATION MANUAL

PRODUCT: TRANSFER CASE SKID PLATE

APPLICATION: DODGE RAM 1500 (2018-Present)

PART NO: 2333.1507.1.6

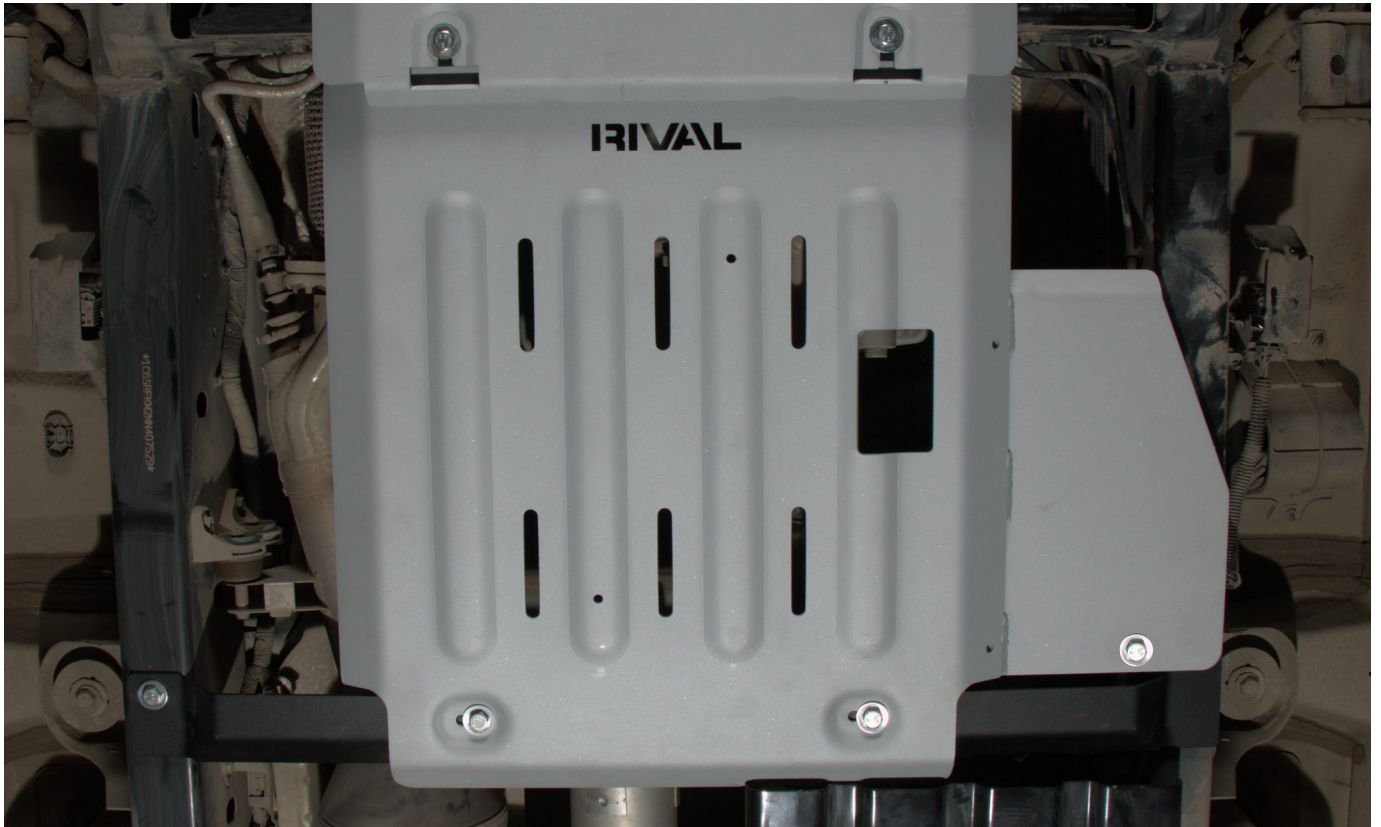

CAUTION!

To reduce the risk of serious injury or damage to property: Before you start installing and using this product, read the full instructions, pay special attention to the conditions of safe use and recommendations for installation! When installing or maintaining this product, it is necessary to use protective goggles. Check the integrity of the structure and the moment the fastening is tightened every 250 miles (400 kms) of mileage. Do not use this product if there is damage to the structure or fasteners!

NOTICE

Skid plate is an additional protection, but it can not guarantee to protect against all possible damage in collisions. When driving, be careful of objects and terrain that may damage sensitive parts of the vehicle.

TRANSFER CASE SKID PLATE

Part number: 2333.1507.1.6

Suited to vehicle: Dodge RAM 1500 V-3.0D; AT; 4WD (2018-Present)

Material: Aluminum



SAFETY NOTICE

- * The RIVAL skid plate is designed to complement the use and design of the specified vehicle under conditions specified by the vehicle manufacturer.
- * While driving the vehicle at any speed, collision with any other vehicle, animal or object must always be avoided.
- * Following any collision with any other vehicle, animal or object, the RIVAL skid plate and the vehicle must be inspected by a specialized or suitably qualified vehicle repairer for possible damage to the components and assemblies in order to confirm suitability for further use of the vehicle.
- * It is strongly recommended that you do not operate a vehicle with a damaged skid plate or its components. In the case of damage, please contact the nearest RIVAL dealer. Vehicle, or where the skid plate has been damaged, is extremely dangerous and must be avoided at all cost.

INSTALLATION NOTICE

- * The RIVAL skid plate must be mounted and affixed to the vehicle according to this installation manual.
- * Personal safety during the installation process must be adhered to at all times.
- * Do not install this skid plate on vehicle models other than those allowed in this manual.
- * Estimated time for installation: 1 hour.

REQUIRED TOOLS

- * Basic tool kit
- * Torque wrench

TORQUE SETTING

- * M10 - 47 N·m (34.7 lb/ft)

PARTS LISTING

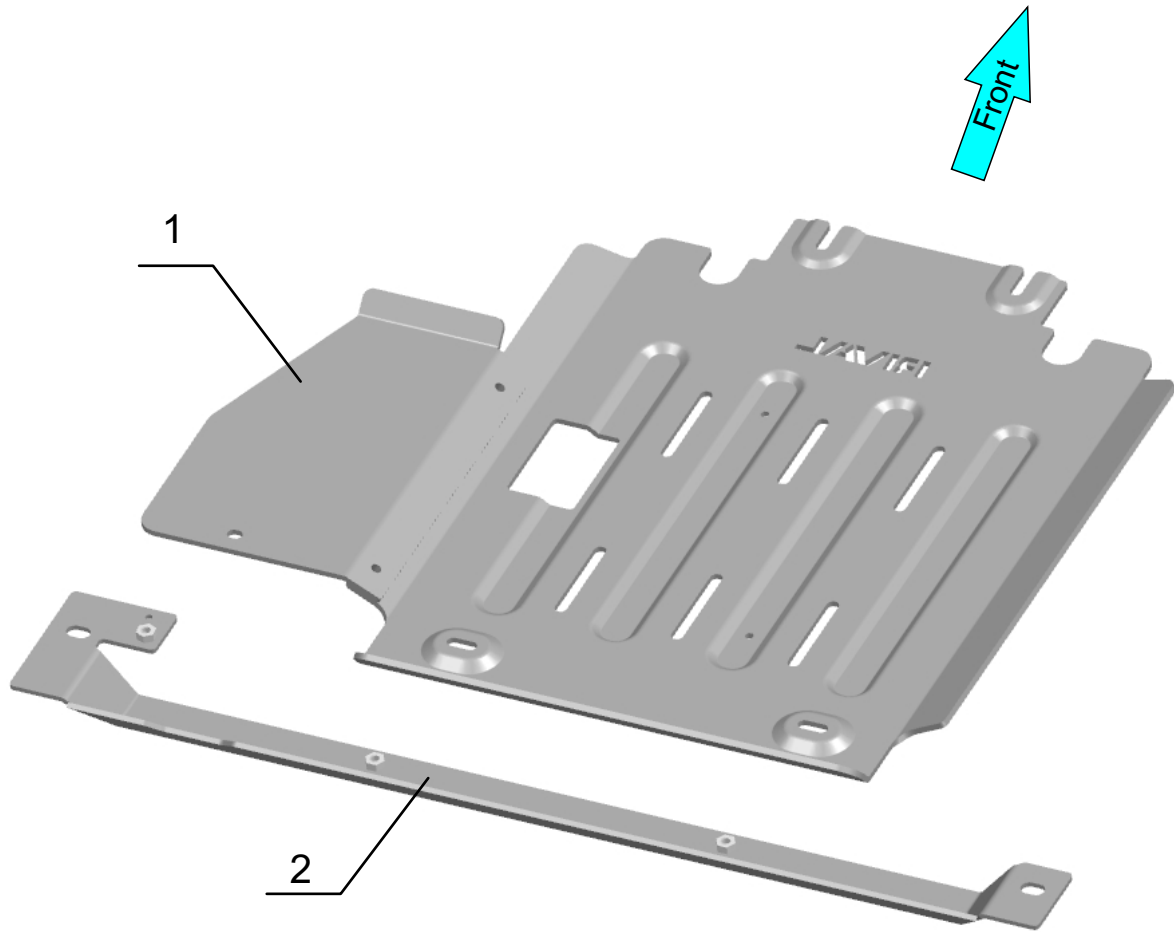

- 1. Transfer case skid plate.....Qty 1
- 2. Crossmember.....Qty 1

PARTS LISTING

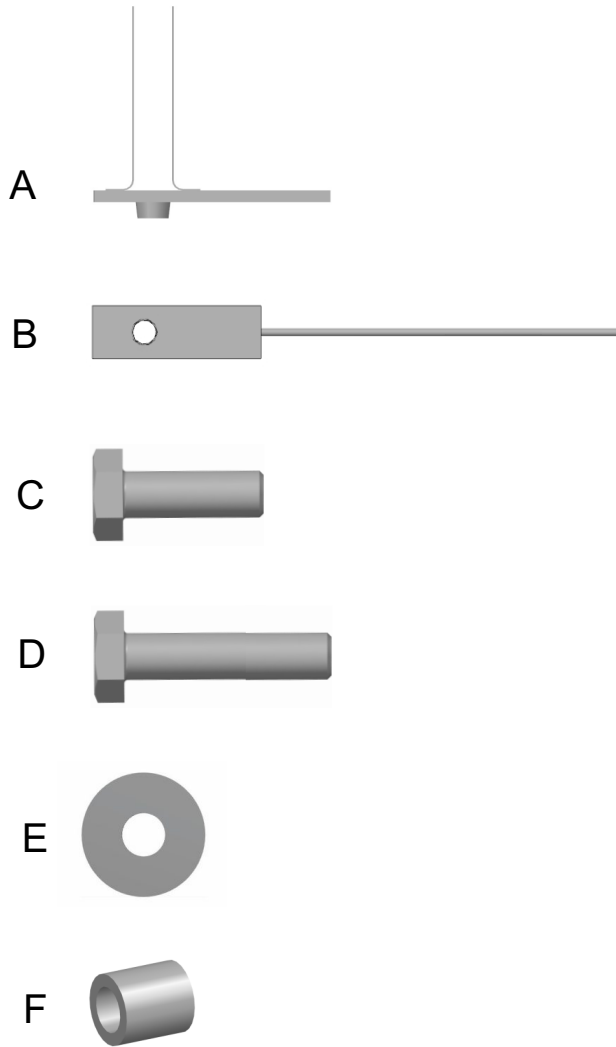

A. Insert nut M10.....	Qty 2
B. Insert nut M10 with wire.....	Qty 2
C. Bolt M10x30.....	Qty 6 (2 pcs. pre-installed)
D. Bolt M10x50.....	Qty 1
E. Flat washer M10.....	Qty 7 (2 pcs. pre-installed)
F. Spacer 22 mm.....	Qty 1

INSTALLATION PROCEDURE

*If equipped, remove factory skid plate or any other aftermarket skid plate.

*Before installation: Remove bolts M10x30 (item C) and flat washers M10 (item E), which ship pre-installed in crossmember (item 2) and transfer case skid plate (item 1). Set aside to reuse later on.

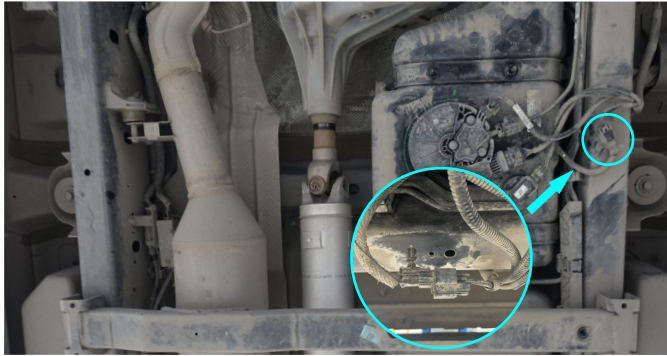

Fig. 1

1. Remove factory wiring from the frame (fig.1).



Fig. 2

2. Install insert nuts M10 with wire (item B) (fig.2).

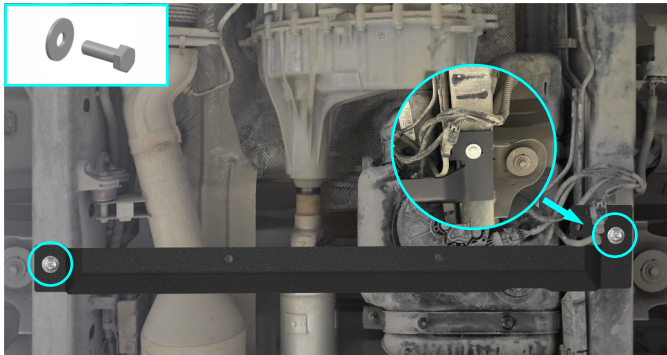

Fig. 3

3. Install crossmember (item 2) as shown in fig.3 and secure it using bolts M10x30 with flat washers M10 (items C, E).

*Do not tighten yet.



Fig. 4

4. Install factory wiring to hole in crossmember (item 2) as shown in fig.4.

If RIVAL transmission skid plate (2333.1505.1.6) is not installed (steps 5-7).

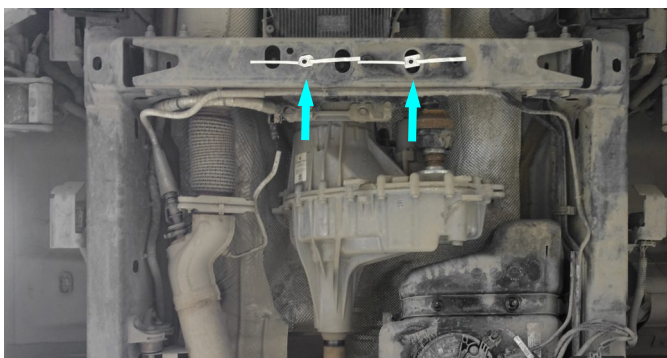

Fig. 5

5. Install insert nuts M10 (item A) as shown in fig.5.

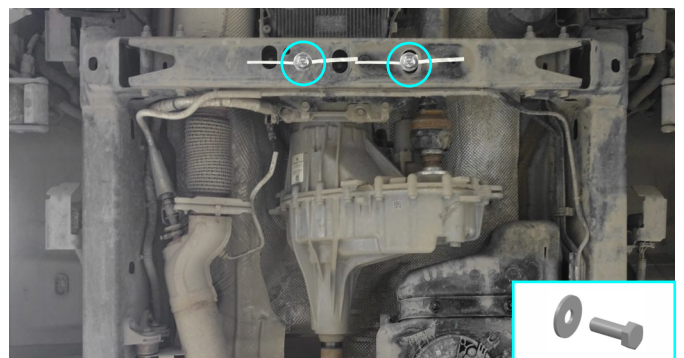

Fig. 6

6. Loosely insert supplied bolts M10x30 with flat washers M10 (items C, E) to insert nuts M10 (item A) (fig.6).

*Do not tighten yet.

INSTALLATION PROCEDURE

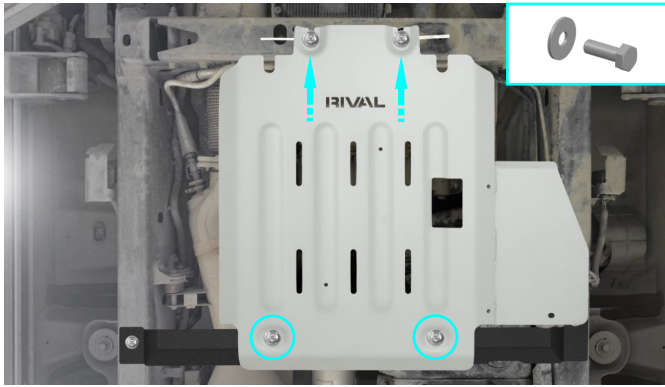

Fig. 7

7. Slide front part of transfer case skid plate (item 1) under previously installed bolts M10x30 from step 6 and secure it using bolts M10x30 with flat washers M10 (items C, E) as shown in fig.7.

***Do not tighten yet.**



Fig. 8

8. Secure transfer case flap (item 1) using bolt M10x50, flat washer M10 and spacer 22 mm (items D, E, F) (fig.8).

***Once all bolts are inserted, tighten all previously installed hardware.**

If RIVAL transmission skid plate (2333.1505.1.6) is installed (steps 9-10).

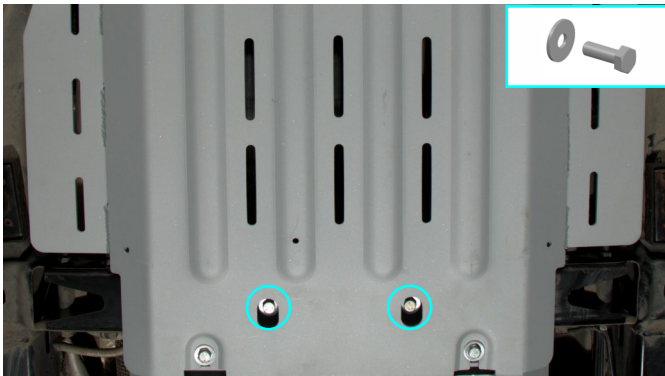

Fig. 9

9. Loosely insert supplied bolts M10x30 with flat washers M10 (items C, E) to rear bracket of RIVAL transmission skid plate (fig.9).

***Do not tighten yet.**

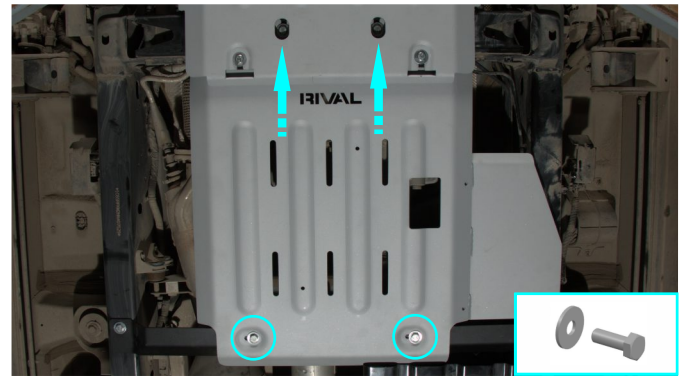

Fig. 10

10. Slide front part of transfer case skid plate (item 1) under previously installed bolts M10x30 from step 9 and secure it using bolts M10x30 with flat washers M10 (items C, E) as shown in fig.10.

***Do not tighten yet.**

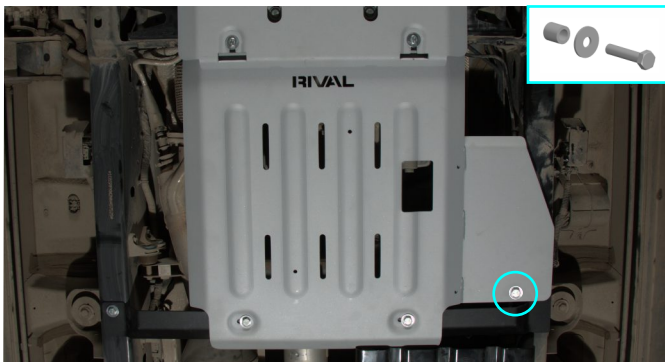

Fig. 11

11. Secure transfer case flap (item 1) using bolt M10x50, flat washer M10 and spacer 22 mm (items D, E, F) (fig.11).

***Once all bolts are inserted, tighten all previously installed hardware.**

INSTALLATION PROCEDURE

Before operating a vehicle fitted with RIVAL Skid Plate:

- make sure all fittings are tightened;
- ensure the integrity of the structure and its components.

