

INSTALLATION MANUAL

PRODUCT: ALUMINUM ENGINE SKID PLATE

APPLICATION: INEOS GRENADIER (2023-PRESENT)

PART NO: 2333.4501.1.6

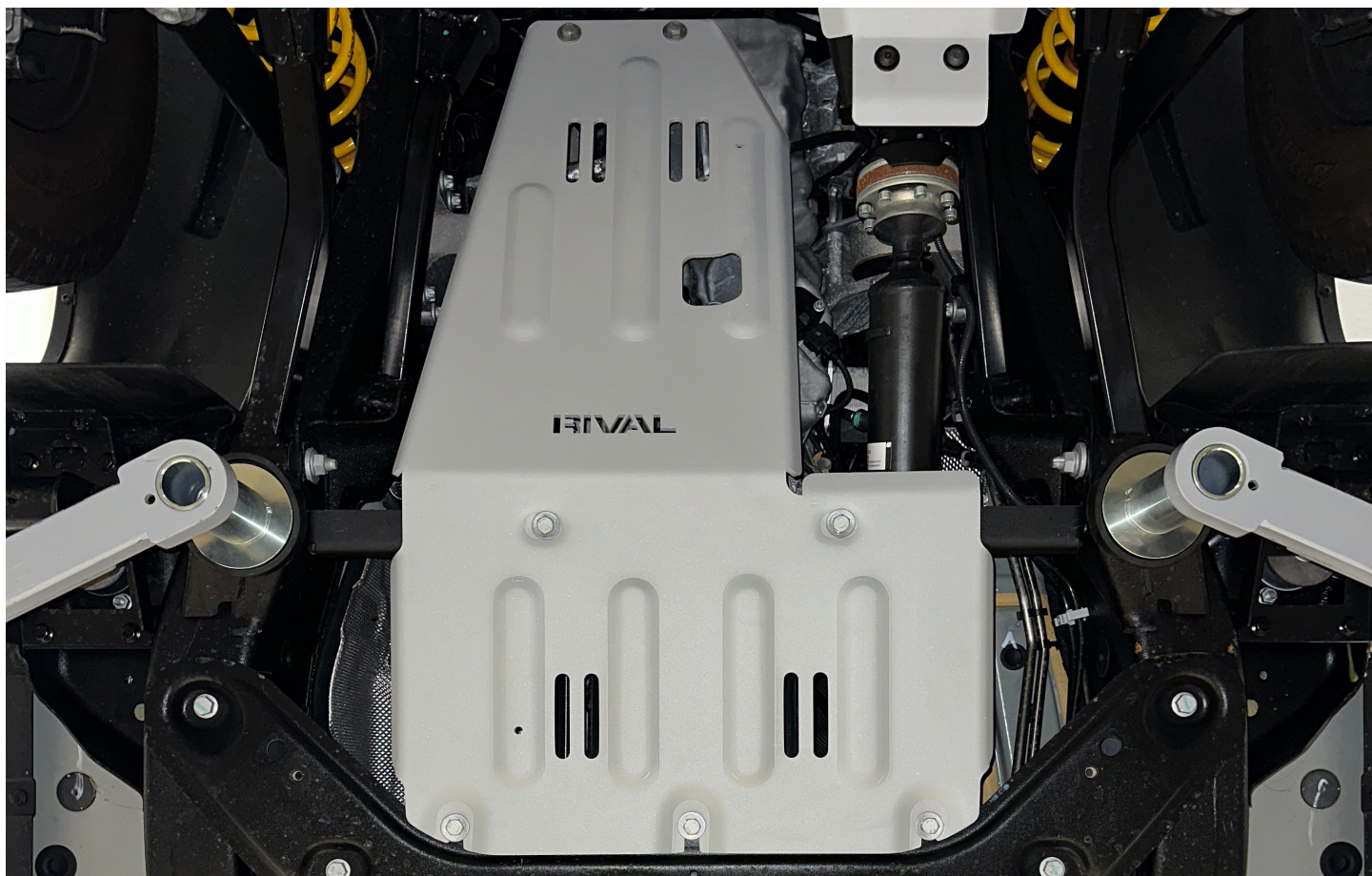

CAUTION!

To reduce the risk of serious injury or damage to property: Before you start installing and using this product, read the full instructions, pay special attention to the conditions of safe use and recommendations for installation! When installing or maintaining this product, it is necessary to use protective goggles. Check the integrity of the structure and the moment the fastening is tightened every 250 miles (400 kms) of mileage. Do not use this product if there is damage to the structure or fasteners!

NOTICE

Skid plate is an additional protection, but it can not guarantee to protect against all possible damage in collisions. When driving, be careful of objects and terrain that may damage sensitive parts of the vehicle.

ENGINE SKID PLATE

Part number 2333.4501.1.6

Suited to vehicle: INEOS GRENADIER (2023-Present), 3.0, 3.0D

Material: Aluminum, steel



SAFETY NOTICE

- * The RIVAL skid plate is designed to complement the use and design of the specified vehicle under conditions specified by the vehicle manufacturer.
- * While driving the vehicle at any speed, collision with any other vehicle, animal or object must always be avoided.
- * Following any collision with any other vehicle, animal or object, the RIVAL skid plate and the vehicle must be inspected by a specialized or suitably qualified vehicle repairer for possible damage to the components and assemblies in order to confirm suitability for further use of the vehicle.
- * It is strongly recommended that you do not operate a vehicle with a damaged skid plate or its components. In the case of damage, please contact the nearest RIVAL dealer. Vehicle, or where the skid plate has been damaged, is extremely dangerous and must be avoided at all cost.

INSTALLATION NOTICE

- * The RIVAL skid plate must be mounted and affixed to the vehicle according to this installation manual.
- * Personal safety during the installation process must be adhered to at all times.
- * Do not install this skid plate on vehicle models other than those allowed in this manual.
- * Estimated time for installation: 1 hour.

REQUIRED TOOLS

- * Basic tool kit
- * Torque wrench

TORQUE SETTING

M10 - 47 H·m (34.7 lb/ft)

PARTS LISTING

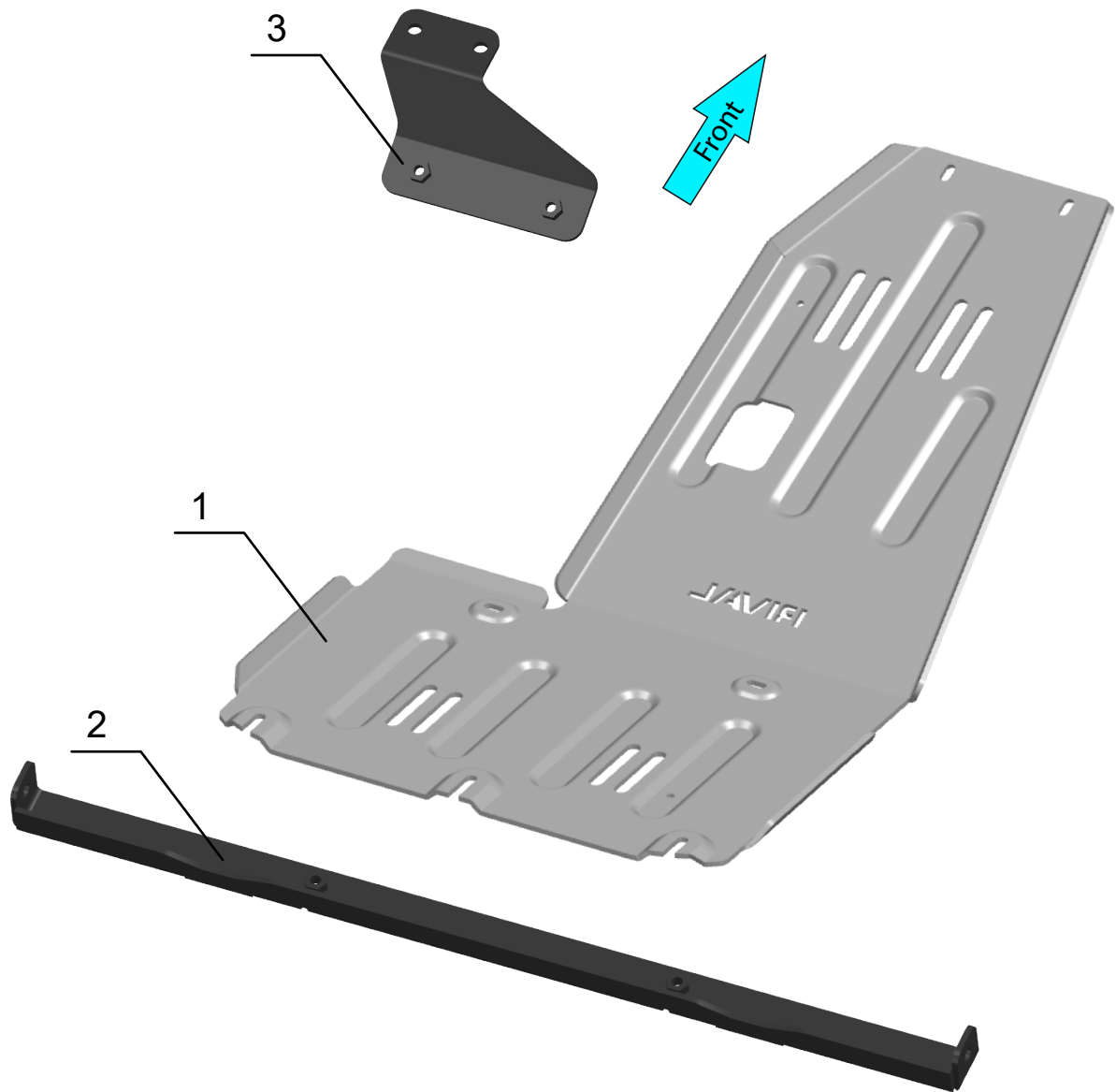

- 1. Engine skid plate.....Qty 1
- 2. Crossmember.....Qty 1
- 3. Bracket.....Qty 1

PARTS LISTING

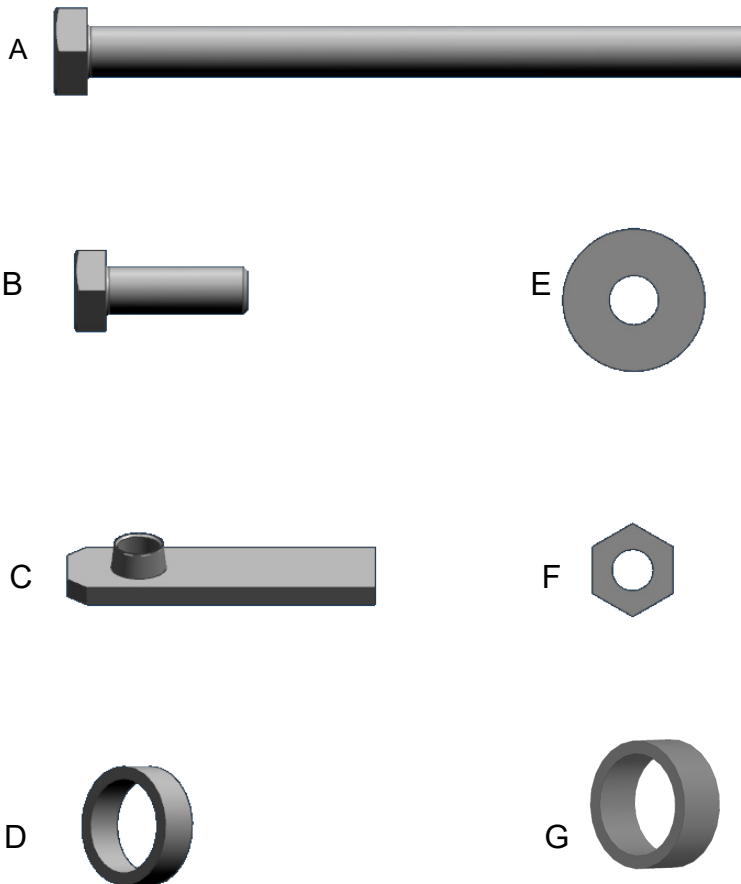

A. Bolt M10x150.....	Qty 2
B. Bolt M10x30.....	Qty 9
C. Insert nut M10.....	Qty 3
D. Spacer 8mm/0.31”.....	Qty 2
E. Washer M10.....	Qty 15
F. Nut M10.....	Qty 4
G. Spacer 10mm/0.39”.....	Qty 2

INSTALLATION PROCEDURE

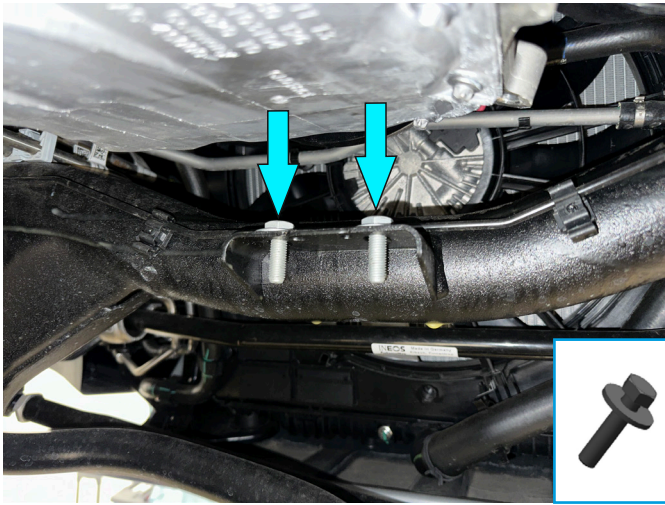

Fig. 1

1. Install bolts M10x30 with washers M10 (items B, E) into holes as shown in fig.1.

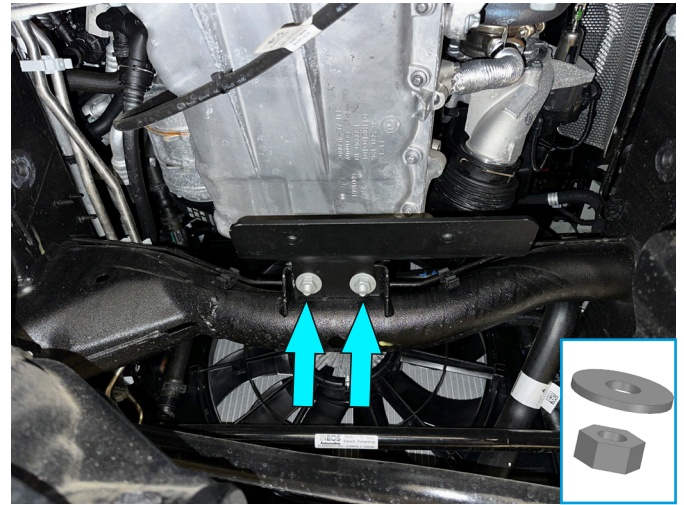

Fig. 2

2. Fix bracket (item 3) to insert bolts using nuts M10 and washers M10 (items F, E) (fig. 2).
***Do not tighten yet.**

Installation without RIVAL radius arm skid plate (2333.4503.1.6)

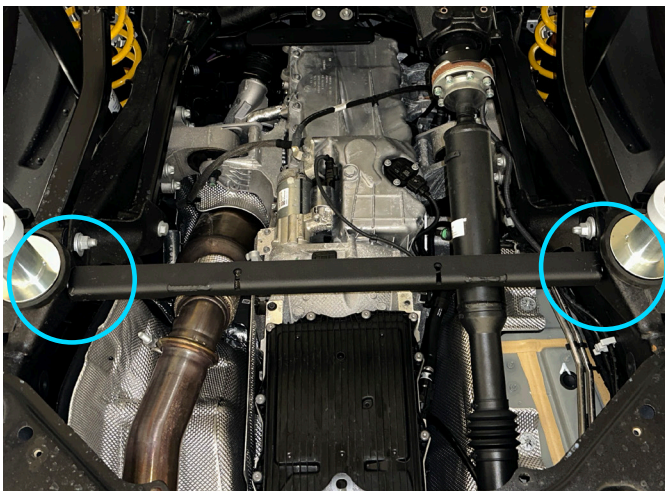

Fig. 3

3. Secure crossmember (item 2) using bolts M10x150 (item A), washers M10 (item E), spacers (items D or G), nuts M10 (item F) as shown in fig. 3 and 4.

***Do not tighten yet.**

****Proceed to step 5**

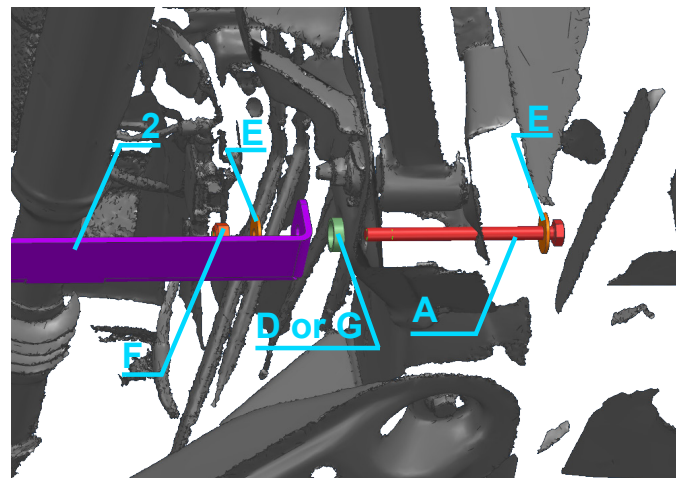

Fig. 4

INSTALLATION PROCEDURE

Installation with RIVAL radius arm skid plate (2333.4503.1.6)

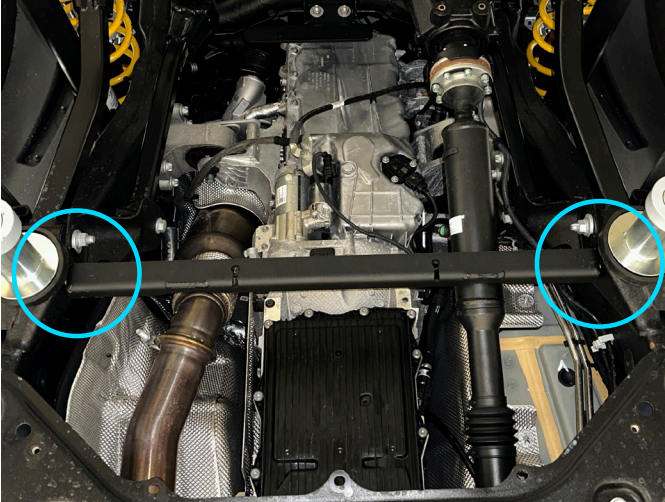

Fig. 5

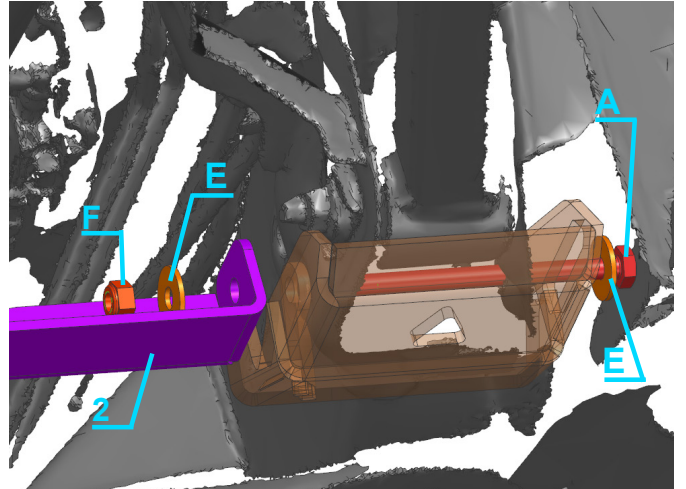

Fig. 6

4. Slide the crossmember (item 2) and slightly screw it on the left side of the vehicle with the radius arm skid plate 2333.4503.1.6 using bolts M10x150, washers M10 and nuts M10 (items A, E, F) as shown in fig 5 and fig. 6. Do the same on the right side of the vehicle.

***Do not tighten yet.**

****Proceed to step 5**

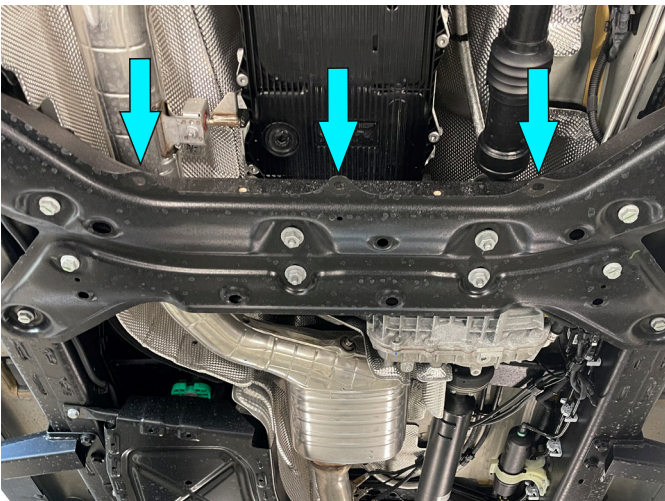

Fig. 7

5. Install insert nuts M10 (item C) into holes as shown in fig.7.

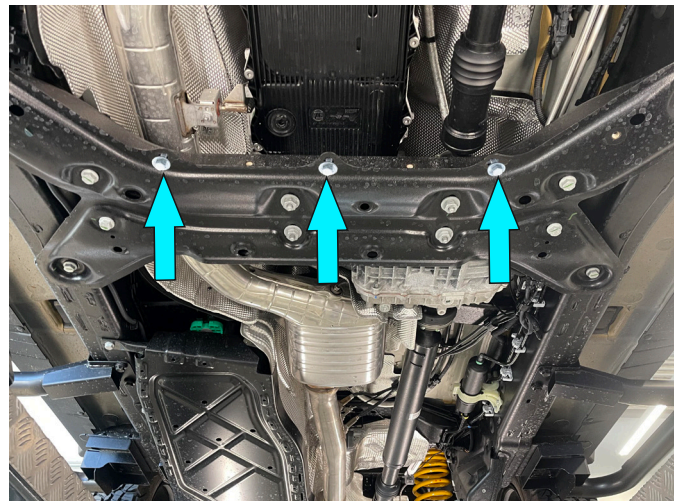

Fig. 8

6. Slightly screw bolts M10x30 with washers M10 (items B, E) into insert nuts M10 from step 5 (fig. 8).

***Do not tighten yet.**

INSTALLATION PROCEDURE

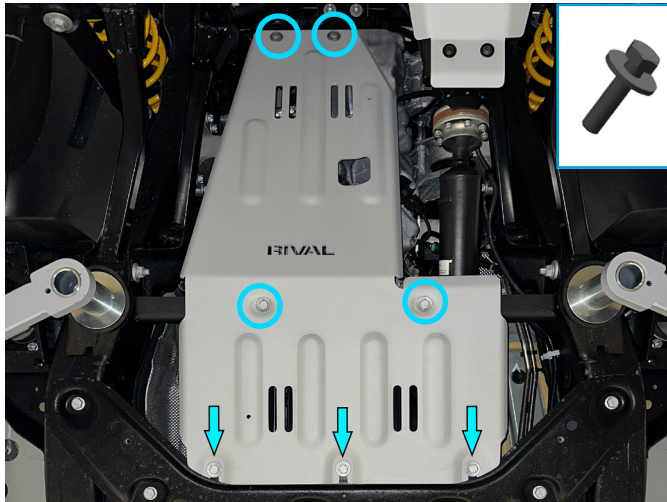

Fig. 9

7. Slide the rear part of engine skid plate (item 1) under previously installed bolts M10x30 from step 6. Secure skid plate to bracket and crossmember using bolts M10x30 and washers M10 (items B, E) (Fig. 9).

***Once all bolts are inserted, check skid plate alignment and tighten all previously installed hardware.**

INSTALLATION PROCEDURE

Before operating a vehicle fitted with RIVAL Skid Plate:

- make sure all fittings are tightened;
- ensure the integrity of the structure and its components.

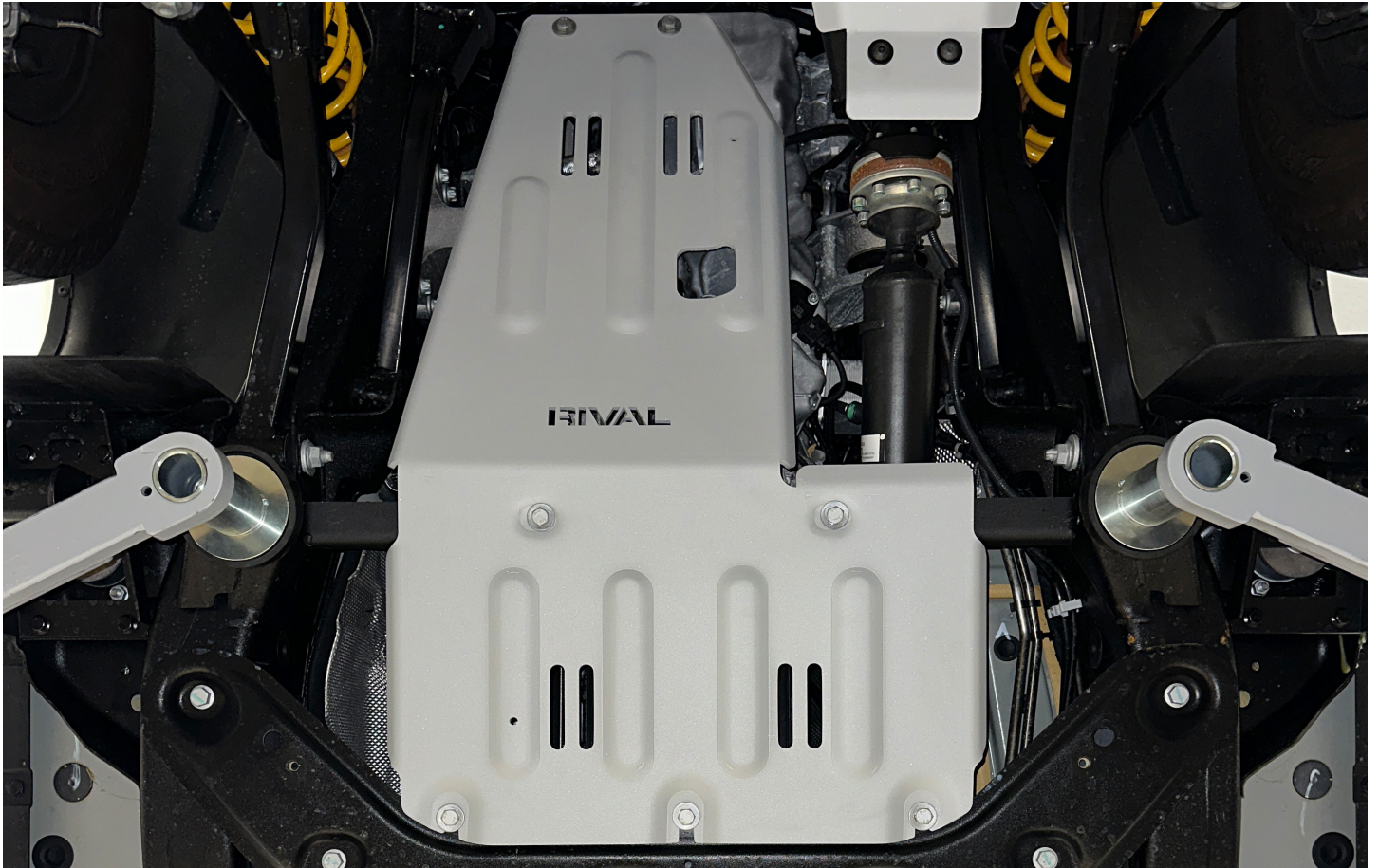

INSTALLATION MANUAL

PRODUCT: TRANSFER CASE SKID PLATE

APPLICATION: INEOS GRENADIER (2023-PRESENT)

PART NO: 2333.4502.2.6



CAUTION!

To reduce the risk of serious injury or damage to property: Before you start installing and using this product, read the full instructions, pay special attention to the conditions of safe use and recommendations for installation! When installing or maintaining this product, it is necessary to use protective goggles. Check the integrity of the structure and the moment the fastening is tightened every 250 miles (400 kms) of mileage. Do not use this product if there is damage to the structure or fasteners!

NOTICE

Skid plate is an additional protection, but it can not guarantee to protect against all possible damage in collisions. When driving, be careful of objects and terrain that may damage sensitive parts of the vehicle.

TRANSFER CASE SKID PLATE

Part number: 2333.4502.2.6

Suited to vehicle: Ineos Grenadier 3.0, 3.0D AT 4WD (2023-Present)

Material: Aluminum, steel



SAFETY NOTICE

- * The RIVAL skid plate is designed to complement the use and design of the specified vehicle under conditions specified by the vehicle manufacturer.
- * While driving the vehicle at any speed, collision with any other vehicle, animal or object must always be avoided.
- * Following any collision with any other vehicle, animal or object, the RIVAL skid plate and the vehicle must be inspected by a specialized or suitably qualified vehicle repairer for possible damage to the components and assemblies in order to confirm suitability for further use of the vehicle.
- * It is strongly recommended that you do not operate a vehicle with a damaged skid plate or its components. In the case of damage, please contact the nearest RIVAL dealer. Vehicle, or where the skid plate has been damaged, is extremely dangerous and must be avoided at all cost.

INSTALLATION NOTICE

- * The RIVAL skid plate must be mounted and affixed to the vehicle according to this installation manual.
- * Personal safety during the installation process must be adhered to at all times.
- * Do not install this skid plate on vehicle models other than those allowed in this manual.
- * Estimated time for installation: 1 hour.

REQUIRED TOOLS

- * Basic tool kit
- * Torque wrench

TORQUE SETTING

- * M10 - 30 N·m (22.1 lb/ft)
- * M12 - 77 N·m (56.8 lb/ft)

PARTS LISTING

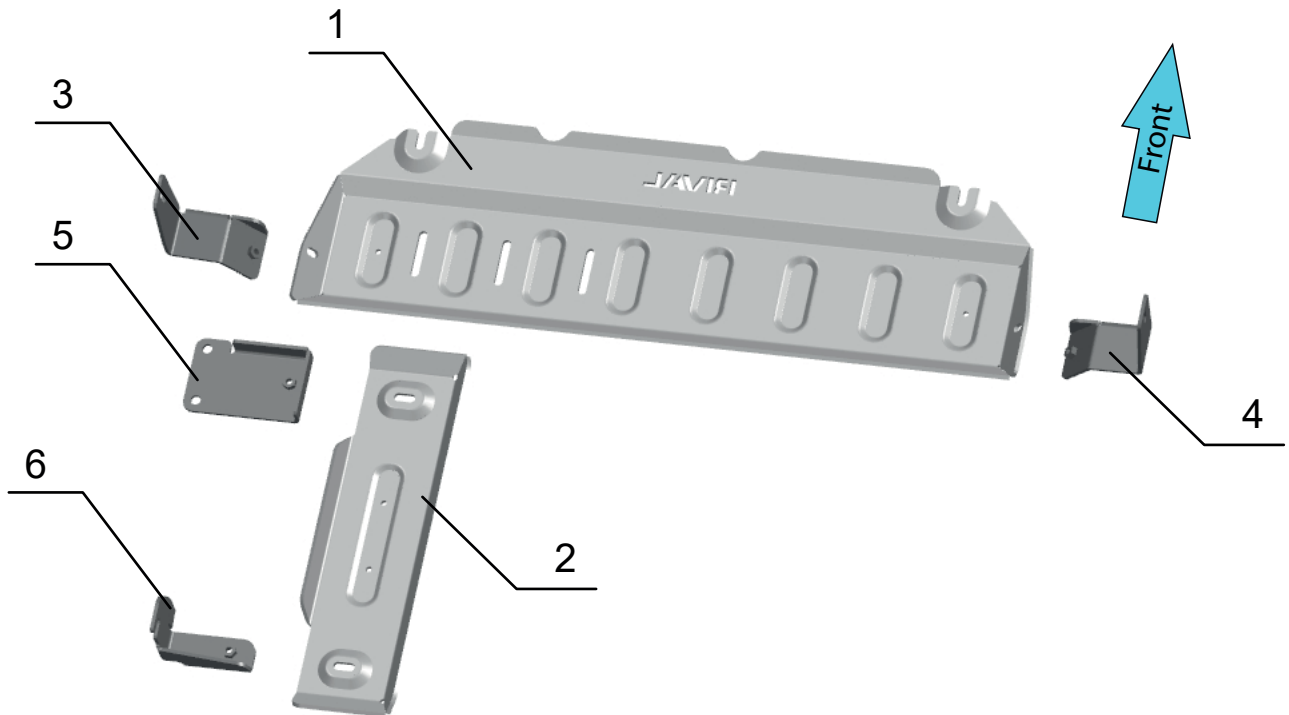

1. Transfer case skid plate.....	Qty 1
2. Fuel filter (diesel)/fuel pipes (gasoline) skid plate.....	Qty 1
3. Bracket left.....	Qty 1
4. Bracket right.....	Qty 1
5. Bracket 1.....	Qty 1
6. Bracket 2.....	Qty 1

PARTS LISTING

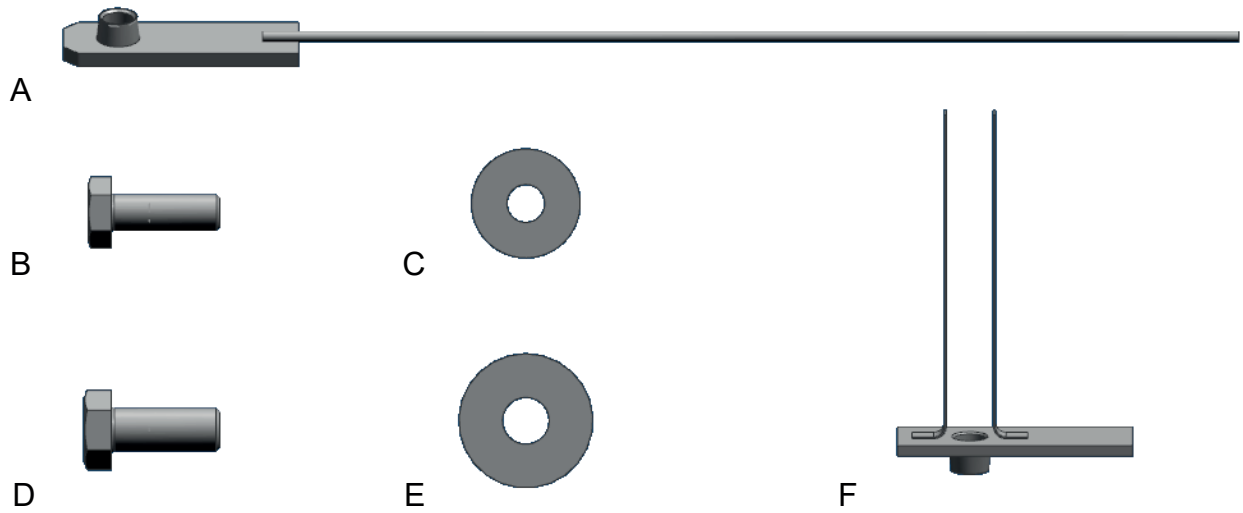

A. Insert nut M10 with wire.....	Qty 2
B. Bolt M10x30.....	Qty 9
C. Washer 10.....	Qty 9
D. Bolt M12x30.....	Qty 2
E. Washer 12.....	Qty 2
F. Insert nut M10 with wires.....	Qty 3

INSTALLATION PROCEDURE

***If equipped, remove the factory skid plate or any other aftermarket skid plate.**

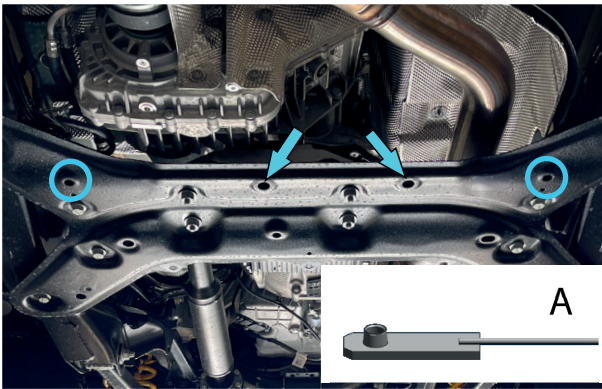

Fig. 1

1. Install insert nuts M10 with wire (item A) into side holes through center holes (fig.1).

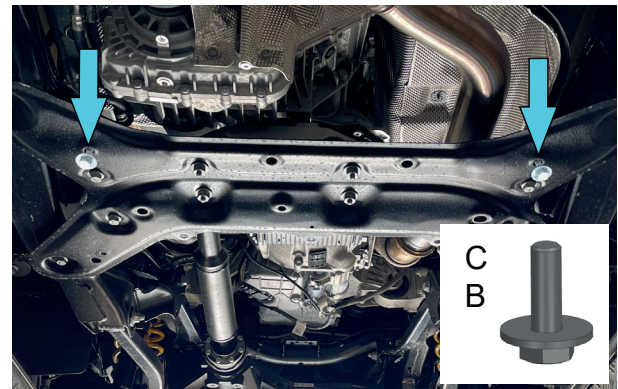

Fig. 2

2. Slightly screw bolts M10x30 with washers 10 (item B, C) into insert nuts M10 from step 1 (fig. 2).

***Do not tighten yet.**

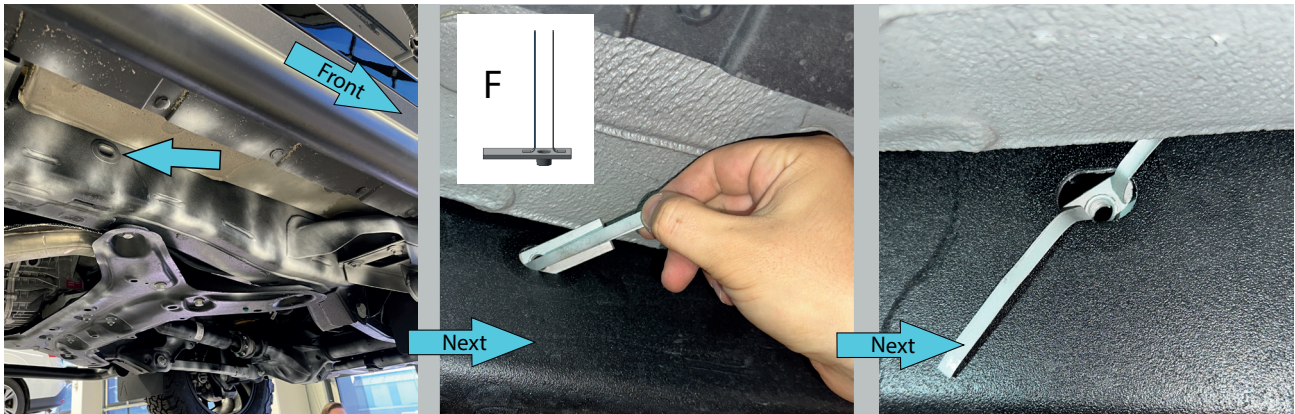

Fig. 3

3. Remove factory plug and install insert nuts M10 with wires (item F) into holes on both sides of the vehicle as shown in fig.3.

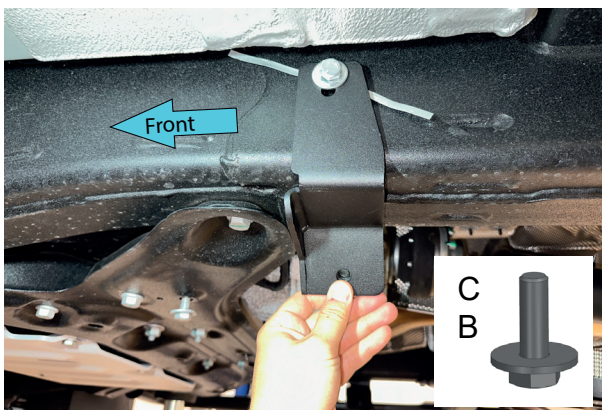

Fig. 4

4. Install left bracket (item 3) and fix it using bolt M10x30 with washer 10 (items B,C).

***Do not tighten yet.**

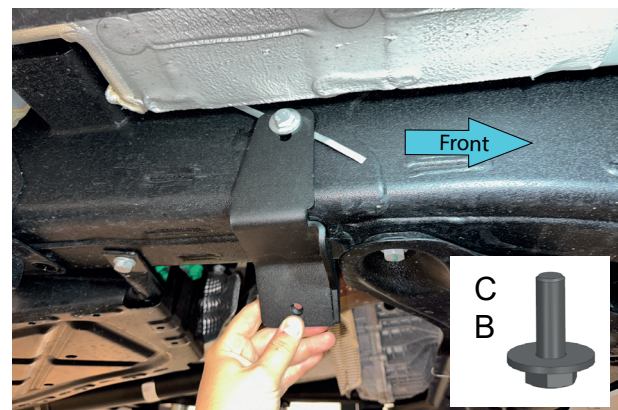

Fig. 5

5. Install right bracket (item 3) and fix it using bolt M10x30 with washer 10 (items B,C).

***Do not tighten yet.**

INSTALLATION PROCEDURE



Fig. 6

6. Slide the transfer case skid plate (item 1) on pre-installed bolts M10x30 from step 2. Fix the skid plate to brackets using bolts M10x30 and washers 10 (items B, C) (Fig. 6).

***Tighten hardware after that.**

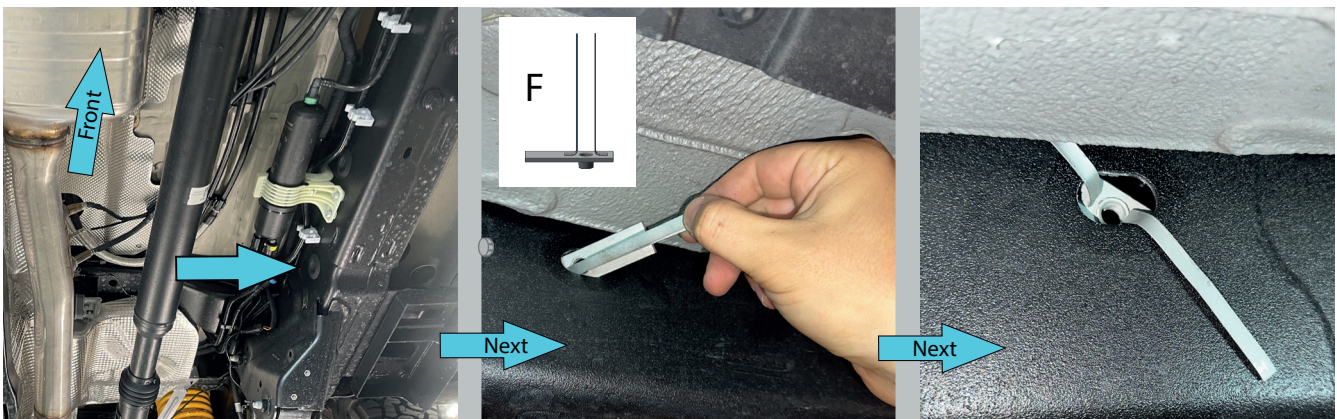

Fig. 7

7. Remove factory plug and install insert nut M10 with wires (item F) into hole as shown in fig.7.

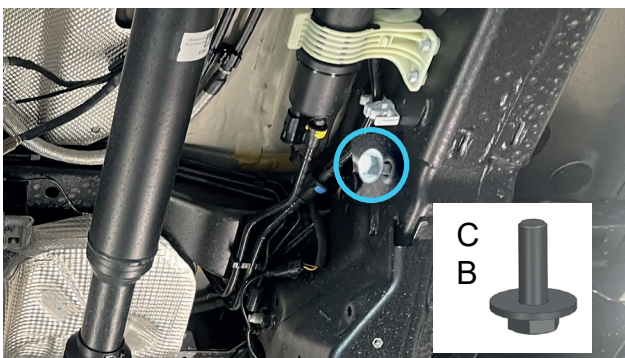

Fig. 8

8. Slightly screw bolt M10x30 with washer 10 (item B, C) into insert nut M10.

***Do not tighten yet.**



Fig. 9

9. Put bracket 2 (item 6) on pre-installed bolts M10x30 from step 8 (fig. 9).

***Do not tighten yet.**

INSTALLATION PROCEDURE

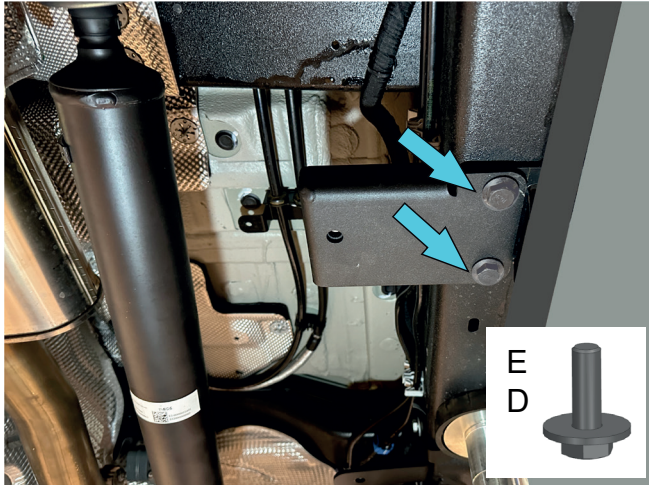

Fig. 10

10. If factory side steps are not pre-installed on vehicle, install and fix bracket 1 (item 5) using bolts M12x30 with washers 12 (items D,E).
***Do not tighten yet.**

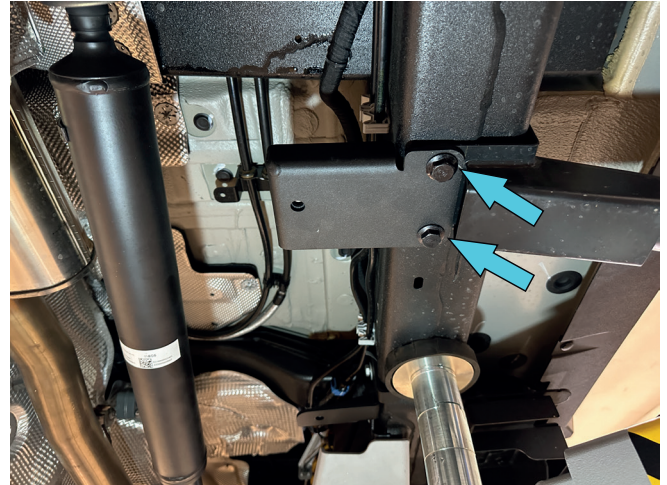

Fig. 11

11. If factory side steps are pre-installed on vehicle, install bracket 1 (item 5) over factory side step brackets as shown in fig.11. Fix bracket 1(item 5) using factory fittings.
***Do not tighten yet.**

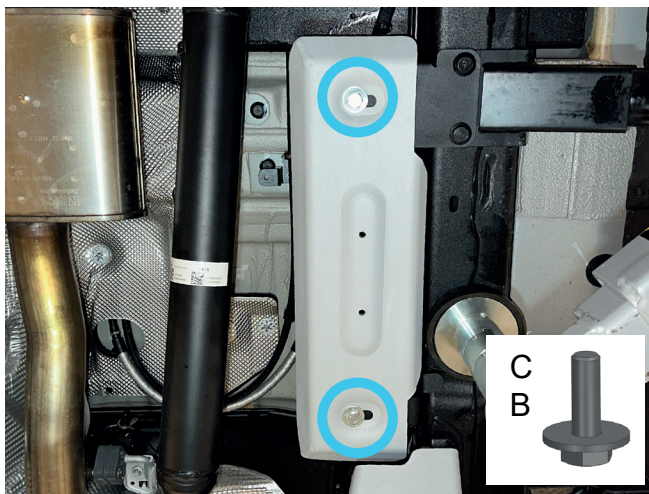

Fig. 12

12. Install the fuel filter (diesel)/fuel pipes (gasoline) skid plate (item 2) on pre-installed brackets. Fix the skid plate using bolts M10x30 and washers 10 (item B, C) (Fig. 12).
***Tighten hardware after that.**

INSTALLATION PROCEDURE

Before operating a vehicle fitted with RIVAL Skid Plate:

- make sure all fittings are tightened;
- ensure the integrity of the structure and its components.



INSTALLATION MANUAL

PRODUCT: RADIUS ARM SKID PLATE

APPLICATION: INEOS GRENADIER (2023-Present)

PART NO: 2333.4503.1.6



CAUTION!

To reduce the risk of serious injury or damage to property: Before you start installing and using this product, read the full instructions, pay special attention to the conditions of safe use and recommendations for installation! When installing or maintaining this product, it is necessary to use protective goggles. Check the integrity of the structure and the moment the fastening is tightened every 250 miles (400 kms) of mileage. Do not use this product if there is damage to the structure or fasteners!

NOTICE

Skid plate is an additional protection, but it can not guarantee to protect against all possible damage in collisions. When driving, be careful of objects and terrain that may damage sensitive parts of the vehicle.

RADIUS ARM SKID PLATE

Part number: 2333.4503.1.6

Suited to vehicle: INEOS GRENADIER (2023-Present), 3.0, 3.0D;
AT; 4WD

Material: Aluminum



SAFETY NOTICE

- * The RIVAL skid plate is designed to complement the use and design of the specified vehicle under conditions specified by the vehicle manufacturer.
- * While driving the vehicle at any speed, collision with any other vehicle, animal or object must always be avoided.
- * Following any collision with any other vehicle, animal or object, the RIVAL skid plate and the vehicle must be inspected by a specialized or suitably qualified vehicle repairer for possible damage to the components and assemblies in order to confirm suitability for further use of the vehicle.
- * It is strongly recommended that you do not operate a vehicle with a damaged skid plate or its components. In the case of damage, please contact the nearest RIVAL dealer. Vehicle, or where the skid plate has been damaged, is extremely dangerous and must be avoided at all cost.

INSTALLATION NOTICE

- * The RIVAL skid plate must be mounted and affixed to the vehicle according to this installation manual.
- * Personal safety during the installation process must be adhered to at all times.
- * Do not install this skid plate on vehicle models other than those allowed in this manual.
- * Estimated time for installation: 1 hour.

REQUIRED TOOLS

- * Basic tool kit
- * Torque wrench

TORQUE SETTING

- * M6 - 9 N·m (6.6 lb/ft)
- * M10 - 30 N·m (22.1 lb/ft)

PARTS LISTING

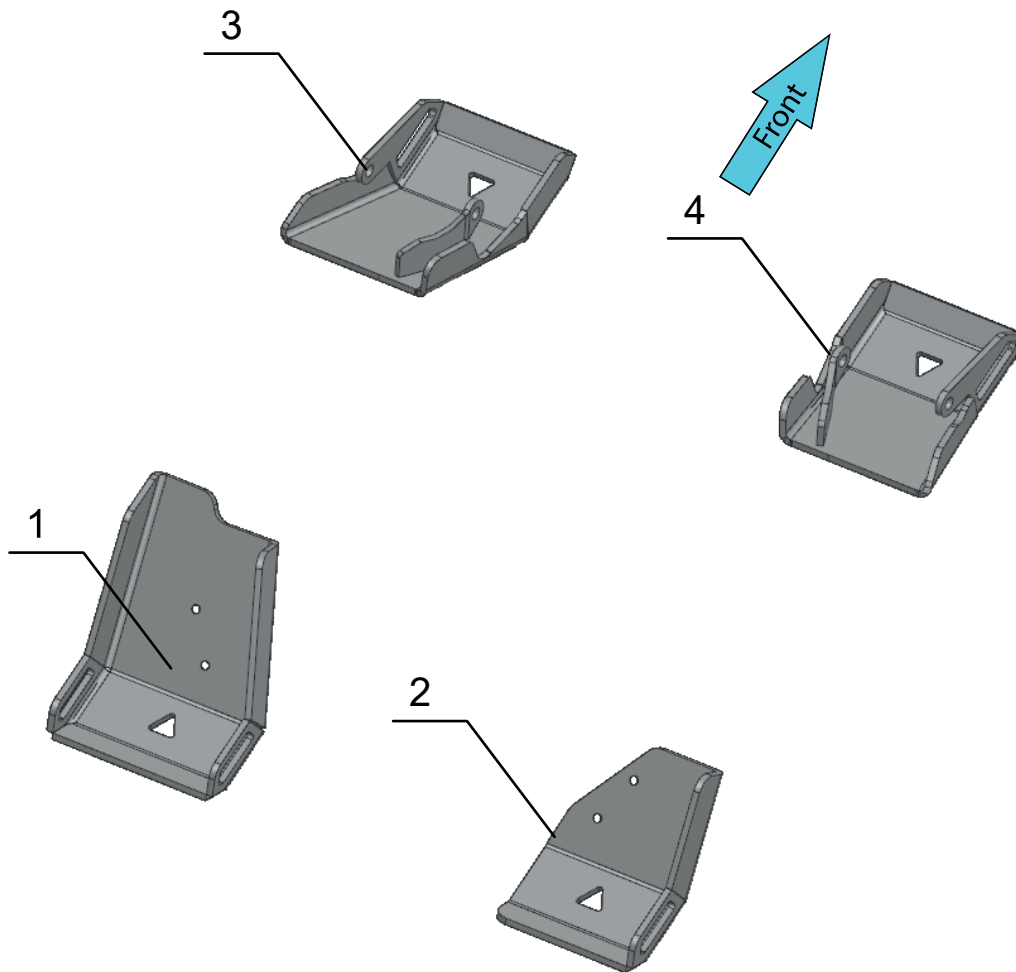

- 1. Rear radius arm skid plate (left).....Qty 1
- 2. Rear radius arm skid plate (right).....Qty 1
- 3. Front radius arm skid plate (left).....Qty 1
- 4. Front radius arm skid plate (right).....Qty 1

PARTS LISTING



A. Bolt M10x140.....	Qty 2
B. Washer 10.....	Qty 4
C. Nut M10.....	Qty 2
D. Screw M6x20.....	Qty 4

INSTALLATION PROCEDURE

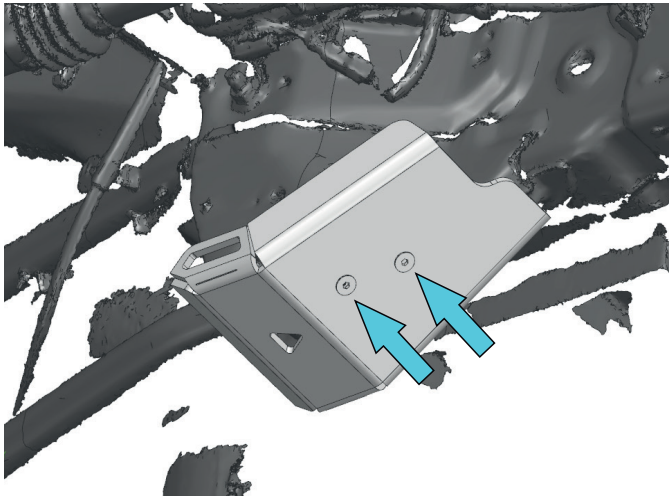

Fig. 1

1. Install the rear arm skid plate (left) (item 1) in factory mounting points using screws M6x20 (item D) (Fig.1).

***Tighten hardware after that.**

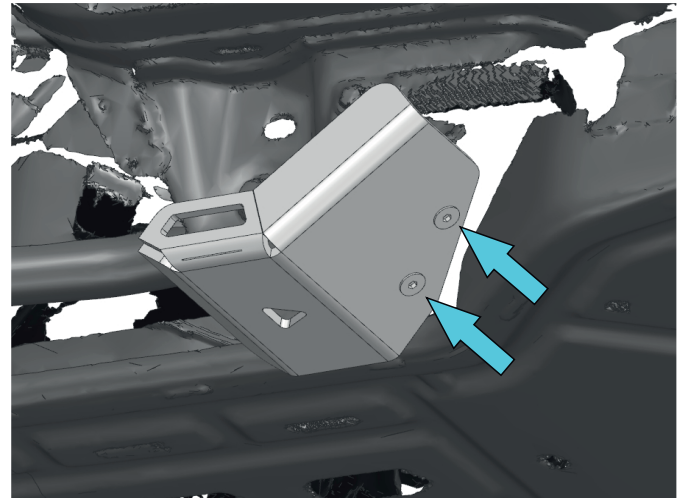

Fig. 2

2. Install the rear arm skid plate (right) (item 2) in factory mounting points using screws M6x20 (item D) (Fig. 2).

***Tighten hardware after that.**

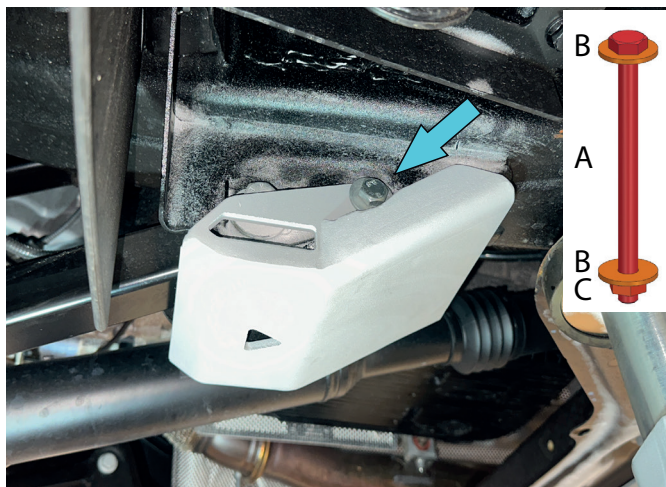

Fig. 3

3. Install the front arm skid plates (right and left) (items 3,4) using bolts M10x140, washers 10 and nuts M10 (items A,B,C) (Fig. 3).

*If you install with RIVAL engine skid plate, unscrew the beam and remove the spacer from step 3 of the RIVAL engine skid plate installation manual. Install the front arm skid plates (right and left) (items 3,4) with the engine skid plate beam using bolts M10x140, washers 10 and nuts M10 (items A,B,C) (Fig. 4).

***Tighten hardware after that.**

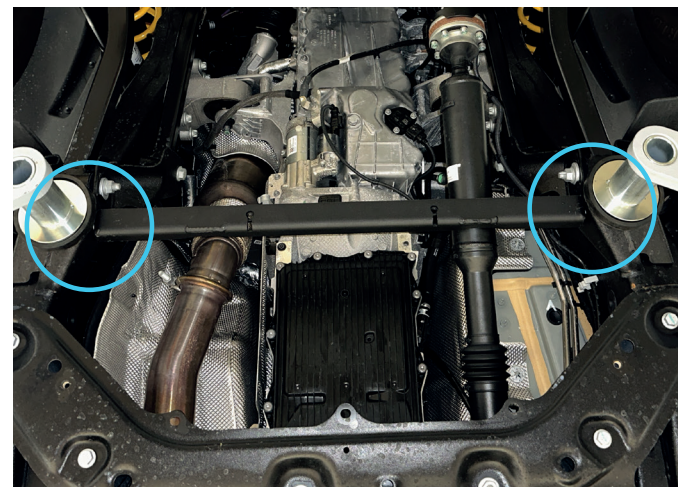

Fig. 4

INSTALLATION PROCEDURE

Before operating a vehicle fitted with RIVAL Skid Plate:

- make sure all fittings are tightened;
- ensure the integrity of the structure and its components.



INSTALLATION MANUAL

PRODUCT: FRONT DIFFERENTIAL SKID PLATE

APPLICATION: INEOS GRENADIER (2023-Present)

PART NO: 2333.4504.1.6



CAUTION!

To reduce the risk of serious injury or damage to property: Before you start installing and using this product, read the full instructions, pay special attention to the conditions of safe use and recommendations for installation! When installing or maintaining this product, it is necessary to use protective goggles. Check the integrity of the structure and the moment the fastening is tightened every 250 miles (400 kms) of mileage. Do not use this product if there is damage to the structure or fasteners!

NOTICE

Skid plate is an additional protection, but it can not guarantee to protect against all possible damage in collisions. When driving, be careful of objects and terrain that may damage sensitive parts of the vehicle.

FRONT DIFFERENTIAL SKID PLATE

Part number: 2333.4504.1.6

Suited to vehicle: Ineos Grenadier V-3.0, 3.0D; AT; 4WD (2023-Present)

Material: Aluminum



SAFETY NOTICE

- * The RIVAL skid plate is designed to complement the use and design of the specified vehicle under conditions specified by the vehicle manufacturer.
- * While driving the vehicle at any speed, collision with any other vehicle, animal or object must always be avoided.
- * Following any collision with any other vehicle, animal or object, the RIVAL skid plate and the vehicle must be inspected by a specialized or suitably qualified vehicle repairer for possible damage to the components and assemblies in order to confirm suitability for further use of the vehicle.
- * It is strongly recommended that you do not operate a vehicle with a damaged skid plate or its components. In the case of damage, please contact the nearest RIVAL dealer. Vehicle, or where the skid plate has been damaged, is extremely dangerous and must be avoided at all cost.

INSTALLATION NOTICE

- * The RIVAL skid plate must be mounted and affixed to the vehicle according to this installation manual.
- * Personal safety during the installation process must be adhered to at all times.
- * Do not install this skid plate on vehicle models other than those allowed in this manual.
- * Estimated time for installation: 1 hour.

REQUIRED TOOLS

- * Basic tool kit
- * Torque wrench

TORQUE SETTING

- * M10 - 47 H·m (34.7 lb/ft)
- * M12 - 77 H·m (56.8 lb/ft)

PARTS LISTING

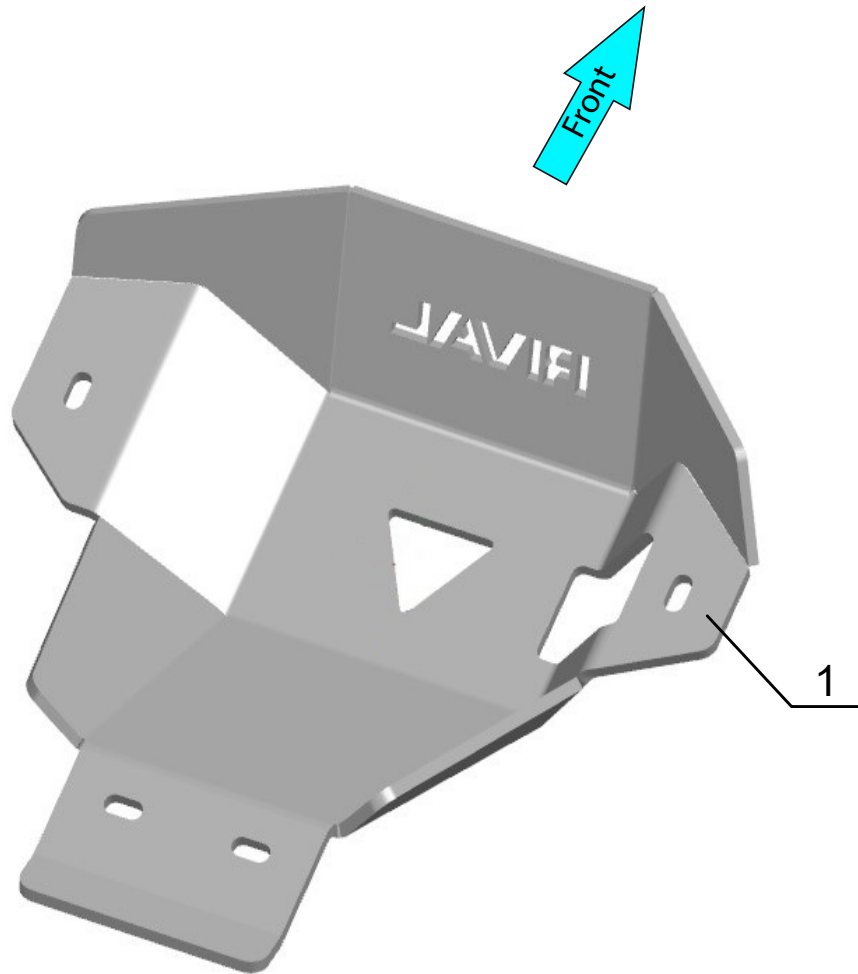

1. Front differential skid plate.....Qty 1

PARTS LISTING

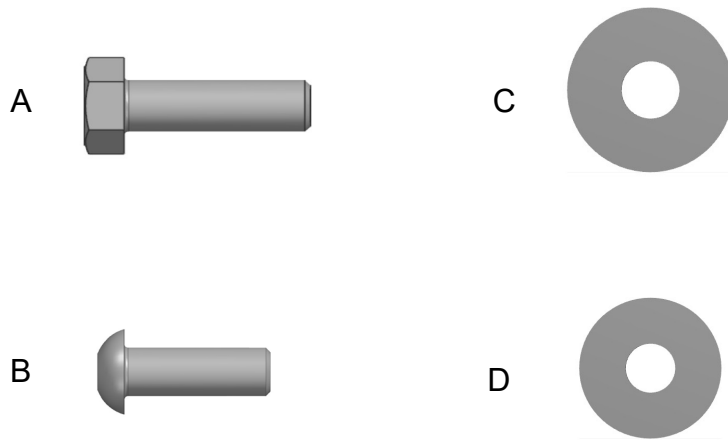

- A. Bolt M12x1.5x30.....Qty 2
- B. Screw M10x25.....Qty 2
- C. Penny washer 12.....Qty 2
- D. Penny washer 10.....Qty 2

INSTALLATION PROCEDURE

***If equipped, remove the factory skid plate or any other aftermarket skid plate.**

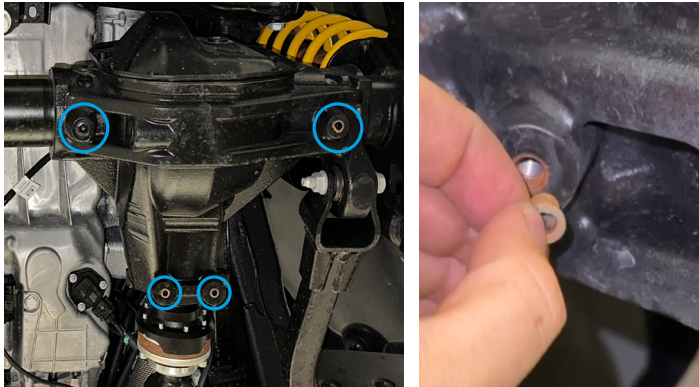

Fig. 1

1. Remove the factory rubber plugs from the threaded holes (fig.1)

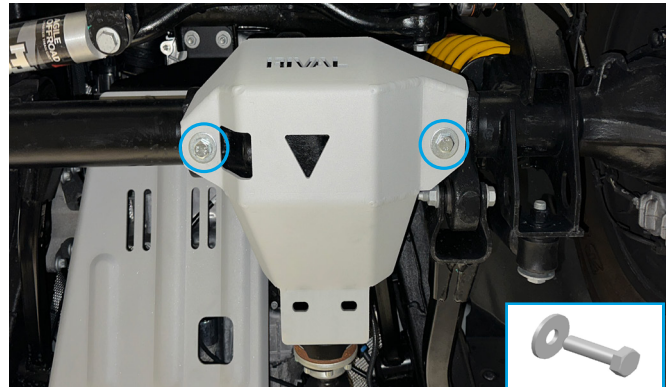

Fig. 2

2. Install the front differential skid plate (item 1) as shown in fig.2 and fix it using bolts M12x1.5x30 and penny washers 12 (items A, C).

***Do not tighten yet.**



Fig. 3

3. Fix the front differential skid plate (item 1) using screws M10x25 and penny washers 10 (items B, D) (fig.3).

***Tighten hardware after that.**

INSTALLATION PROCEDURE

Before operating a vehicle fitted with RIVAL Skid Plate:

- make sure all fittings are tightened;
- ensure the integrity of the structure and its components.



INSTALLATION MANUAL

PRODUCT: REAR DIFFERENTIAL SKID PLATE

APPLICATION: INEOS GRENADIER (2023-Present)

PART NO: 2333.4505.1.6

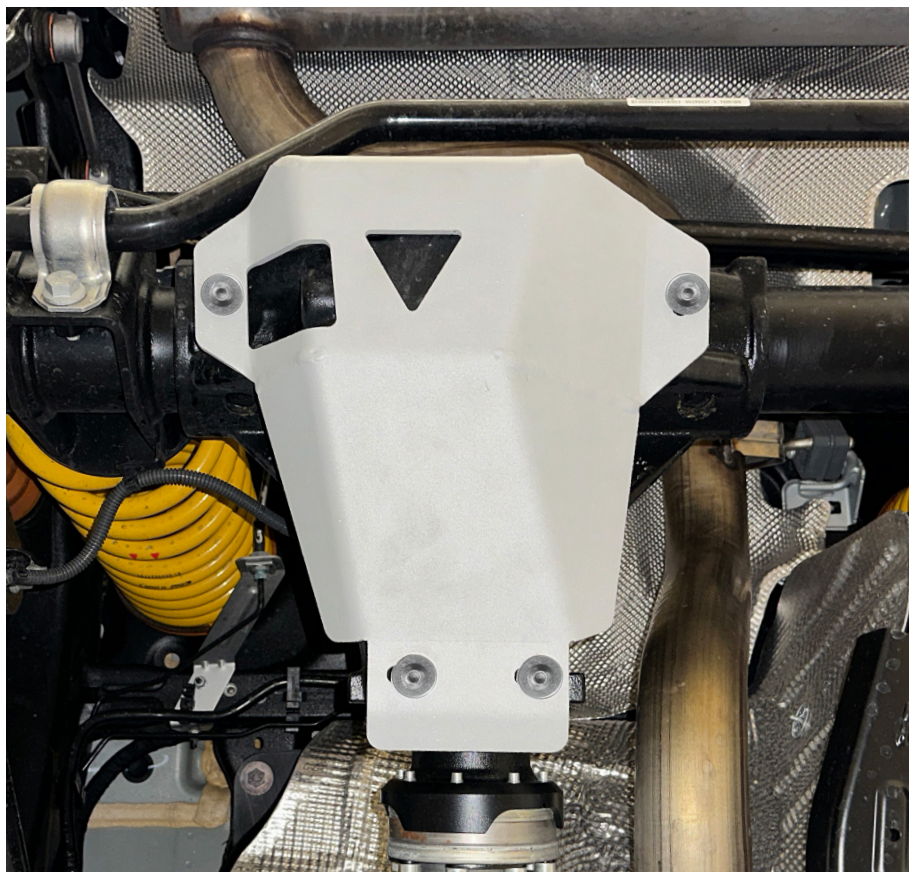

CAUTION!

To reduce the risk of serious injury or damage to property: Before you start installing and using this product, read the full instructions, pay special attention to the conditions of safe use and recommendations for installation! When installing or maintaining this product, it is necessary to use protective goggles. Check the integrity of the structure and the moment the fastening is tightened every 250 miles (400 kms) of mileage. Do not use this product if there is damage to the structure or fasteners!

NOTICE

Skid plate is an additional protection, but it can not guarantee to protect against all possible damage in collisions. When driving, be careful of objects and terrain that may damage sensitive parts of the vehicle.

REAR DIFFERENTIAL SKID PLATE

Part number: 2333.4505.1.6

Suited to vehicle: Ineos Grenadier V-3.0, 3.0D; AT; 4WD (2023-Present)

Material: Aluminum



SAFETY NOTICE

- * The RIVAL skid plate is designed to complement the use and design of the specified vehicle under conditions specified by the vehicle manufacturer.
- * While driving the vehicle at any speed, collision with any other vehicle, animal or object must always be avoided.
- * Following any collision with any other vehicle, animal or object, the RIVAL skid plate and the vehicle must be inspected by a specialized or suitably qualified vehicle repairer for possible damage to the components and assemblies in order to confirm suitability for further use of the vehicle.
- * It is strongly recommended that you do not operate a vehicle with a damaged skid plate or its components. In the case of damage, please contact the nearest RIVAL dealer. Vehicle, or where the skid plate has been damaged, is extremely dangerous and must be avoided at all cost.

INSTALLATION NOTICE

- * The RIVAL skid plate must be mounted and affixed to the vehicle according to this installation manual.
- * Personal safety during the installation process must be adhered to at all times.
- * Do not install this skid plate on vehicle models other than those allowed in this manual.
- * Estimated time for installation: 1 hour.

REQUIRED TOOLS

- * Basic tool kit
- * Torque wrench

TORQUE SETTING

- * M10 - 47 H·m (34.7 lb/ft)

PARTS LISTING

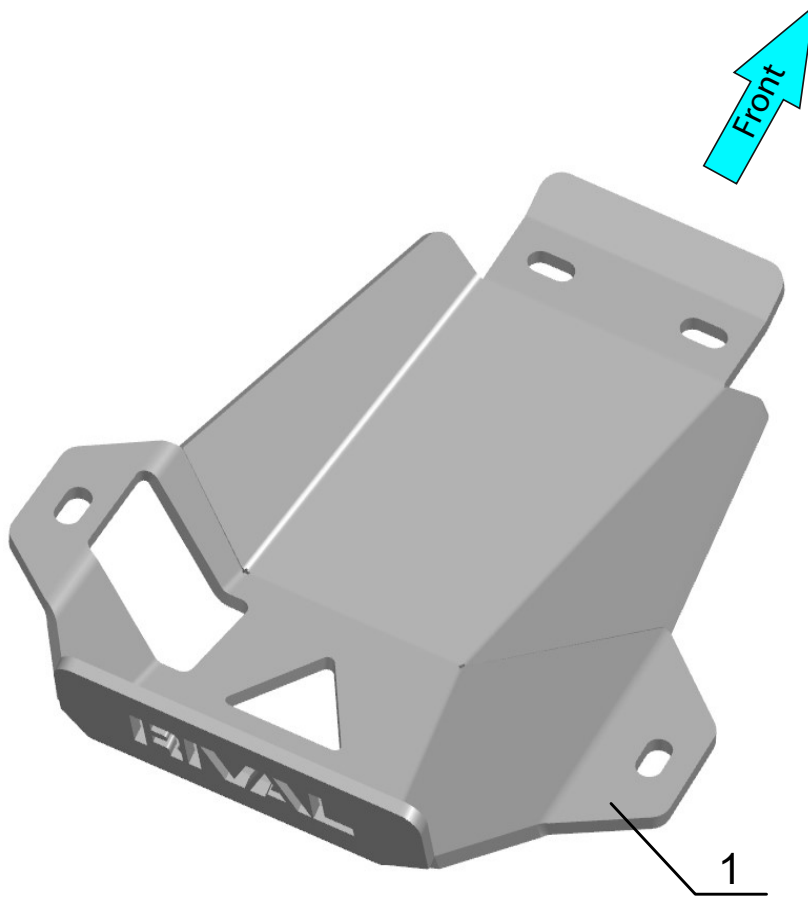

1. Rear differential skid plate.....Qty 1

PARTS LISTING

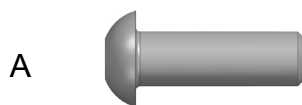

A. Screw M10x25.....	Qty 4
B. Penny washer 10.....	Qty 4

INSTALLATION PROCEDURE

***If equipped, remove the factory skid plate or any other aftermarket skid plate.**

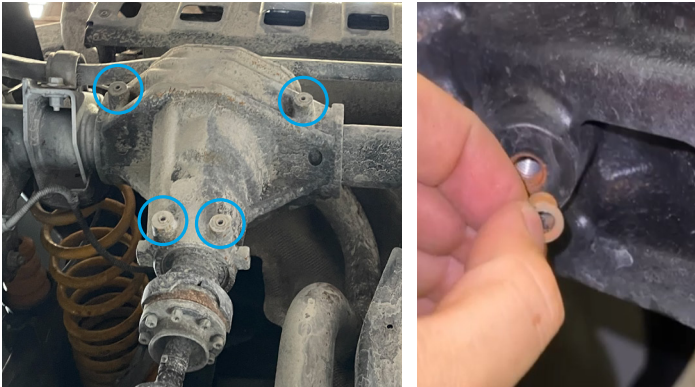

Fig. 1

1. Remove the factory rubber plugs from the threaded holes (fig.1).

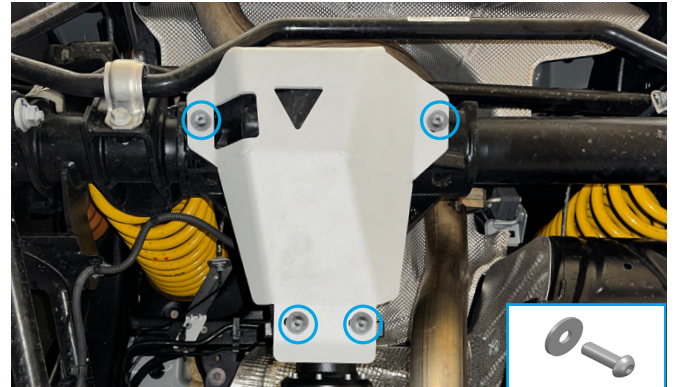

Fig. 2

2. Install the rear differential skid plate (item 1) as shown in fig.2 and fix it using screws M10x25 and penny washers 10 (items A, B).

INSTALLATION PROCEDURE

Before operating a vehicle fitted with RIVAL Skid Plate:

- make sure all fittings are tightened;
- ensure the integrity of the structure and its components.

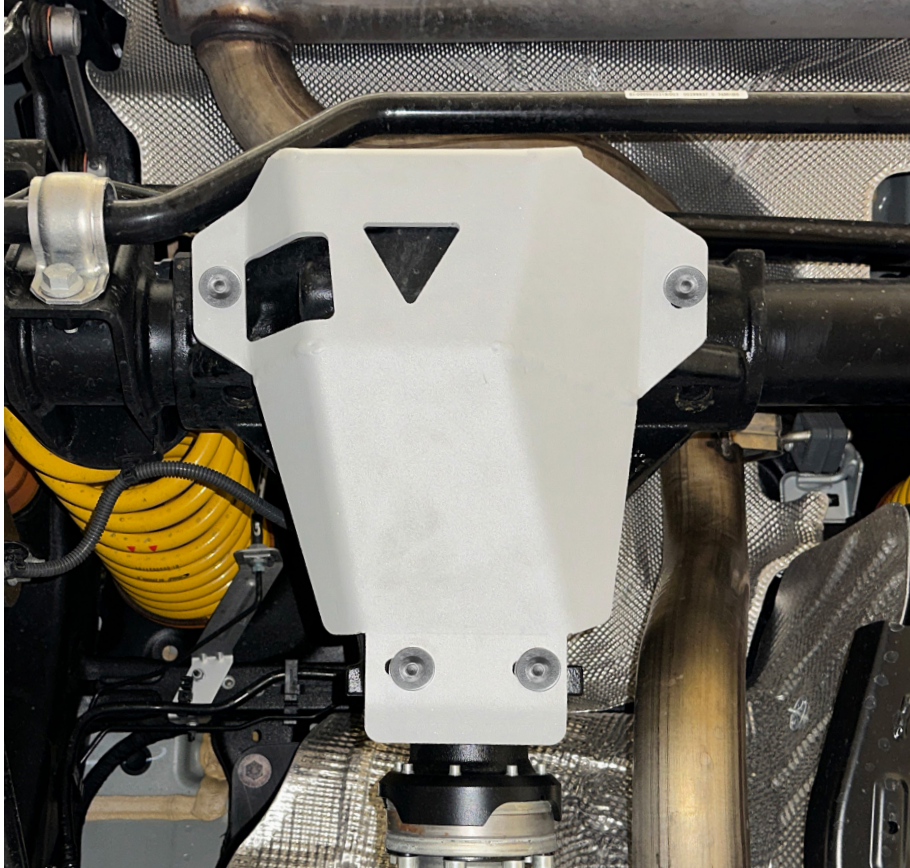

INSTALLATION MANUAL

PRODUCT: FUEL TANK SKID PLATE

APPLICATION: INEOS GRENADIER (2023-PRESENT)

PART NO: 2333.4506.1.6



CAUTION!

To reduce the risk of serious injury or damage to property: Before you start installing and using this product, read the full instructions, pay special attention to the conditions of safe use and recommendations for installation! When installing or maintaining this product, it is necessary to use protective goggles. Check the integrity of the structure and the moment the fastening is tightened every 250 miles (400 kms) of mileage. Do not use this product if there is damage to the structure or fasteners!

NOTICE

Skid plate is an additional protection, but it can not guarantee to protect against all possible damage in collisions. When driving, be careful of objects and terrain that may damage sensitive parts of the vehicle.

FUEL TANK SKID PLATE

Part number: 2333.4506.1.6

Suited to vehicle: Ineos Grenadier (2023-Present) 3.0, 3.0D

Material: Aluminum / Steel



SAFETY NOTICE

- * The RIVAL skid plate is designed to complement the use and design of the specified vehicle under conditions specified by the vehicle manufacturer.
- * While driving the vehicle at any speed, collision with any other vehicle, animal or object must always be avoided.
- * Following any collision with any other vehicle, animal or object, the RIVAL skid plate and the vehicle must be inspected by a specialized or suitably qualified vehicle repairer for possible damage to the components and assemblies in order to confirm suitability for further use of the vehicle.
- * It is strongly recommended that you do not operate a vehicle with a damaged skid plate or its components. In the case of damage, please contact the nearest RIVAL dealer. Vehicle, or where the skid plate has been damaged, is extremely dangerous and must be avoided at all cost.

INSTALLATION NOTICE

- * The RIVAL skid plate must be mounted and affixed to the vehicle according to this installation manual.
- * Personal safety during the installation process must be adhered to at all times.
- * Do not install this skid plate on vehicle models other than those allowed in this manual.
- * Estimated time for installation: 1 hour.

REQUIRED TOOLS

- * Basic tool kit
- * Torque wrench

TORQUE SETTING

- * M8 - 24 H·m (17.7 lb/ft)

PARTS LISTING

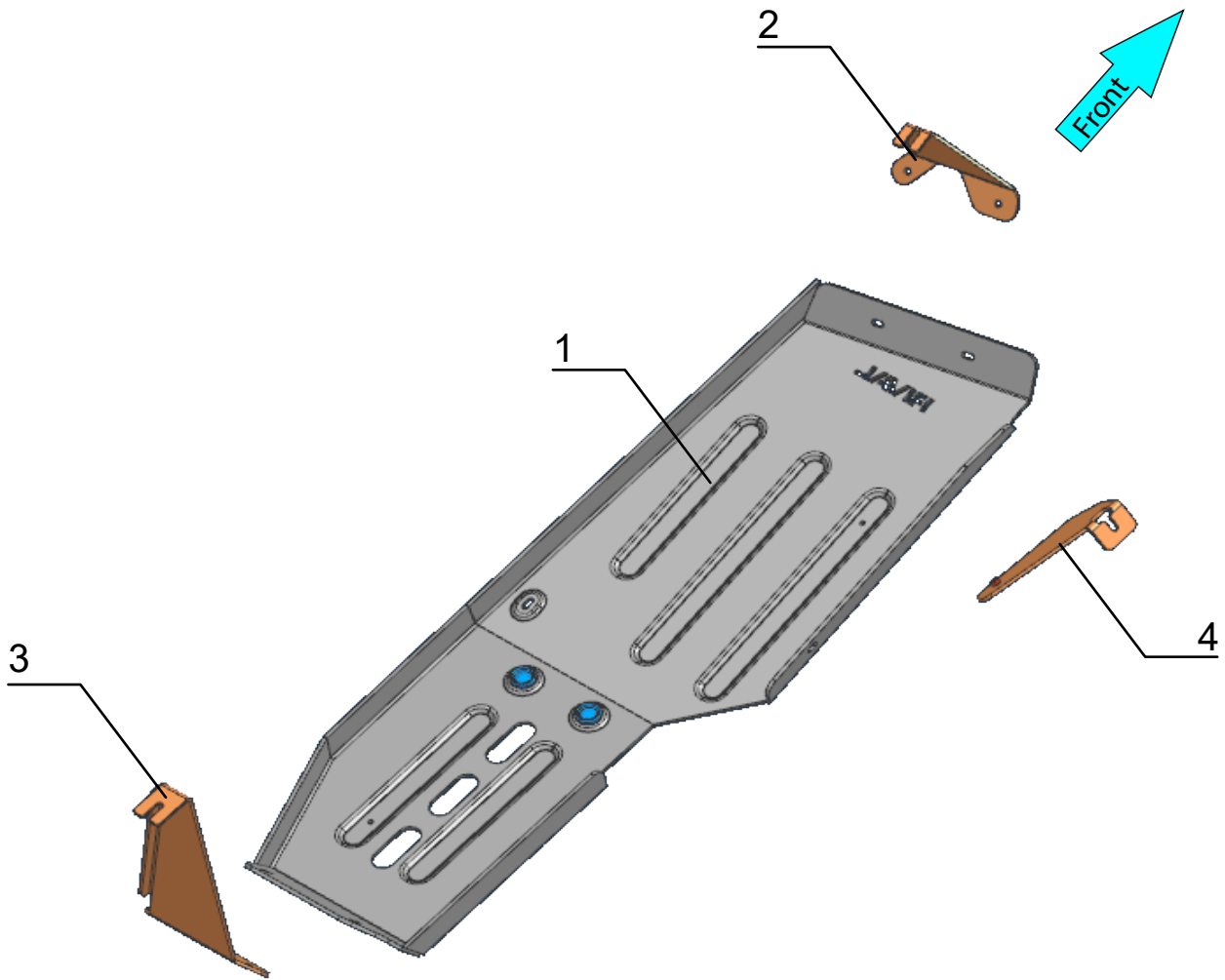

- 1. Skid plate.....Qty 1
- 2. Front bracketQty 1
- 3. Rear bracket.....Qty 1
- 4. Side bracket.....Qty 1

PARTS LISTING

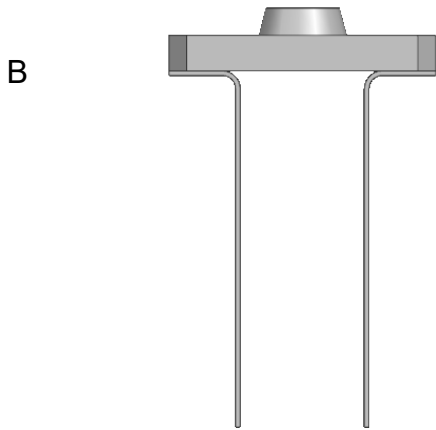
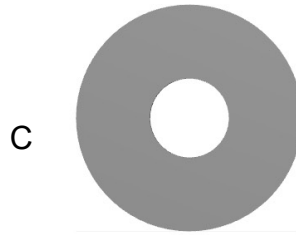
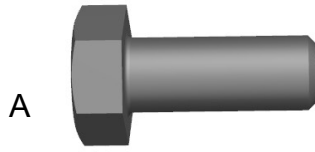

A. Bolt M8x25.....	Qty 6
B. Insert nut M8.....	Qty 1
C. Washer 8.....	Qty 6

INSTALLATION PROCEDURE

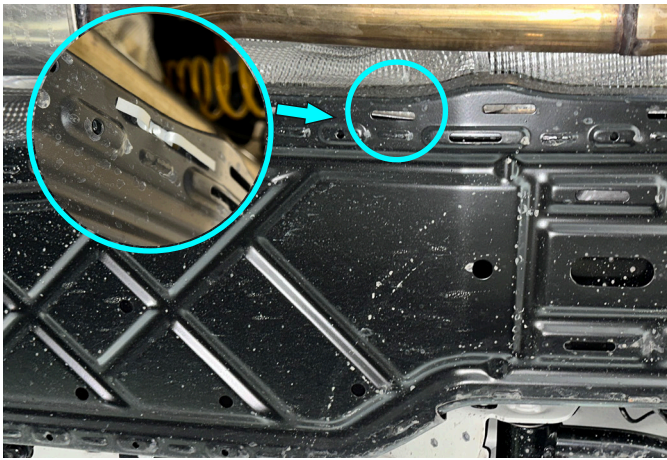

Fig. 1

1. Install insert nut M8 (item B) as shown in fig.1

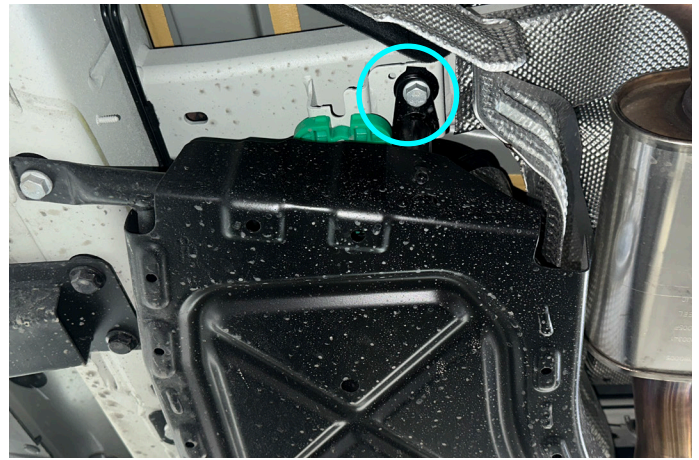

Fig. 2

2. Loosen front factory bolt as shown in fig. 2

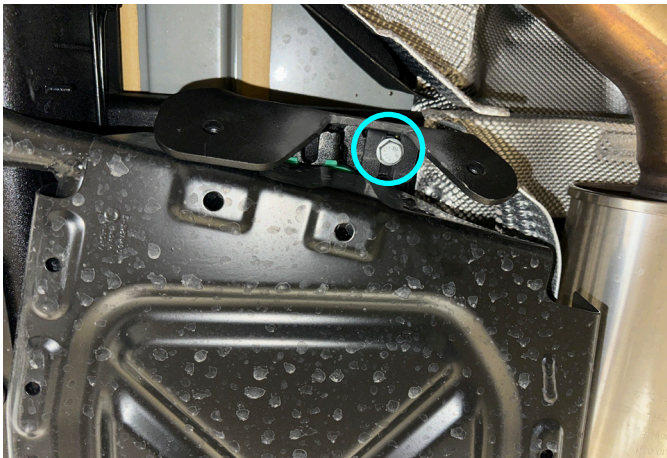

Fig. 3

3. Install the front bracket (item 2) and fix it using factory bolt as shown in fig.3.
***Do not tighten yet.**

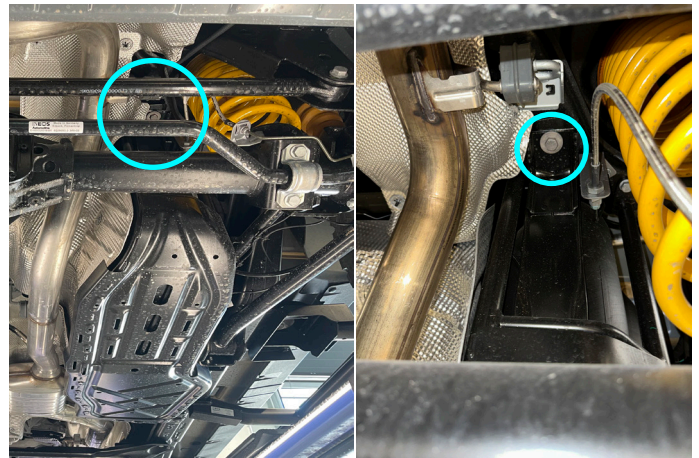

Fig. 4

4. Loosen rear factory bolt as shown in fig.4

INSTALLATION PROCEDURE

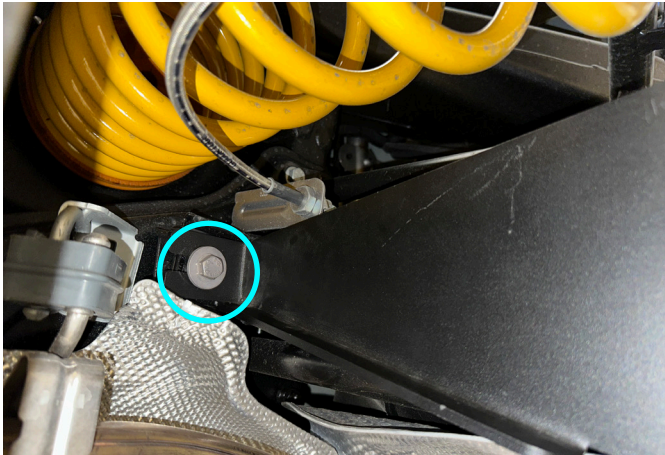

Fig. 5

5. Install the rear bracket (item 3) and fix it using factory bolt as shown in fig.5.

***Do not tighten yet.**

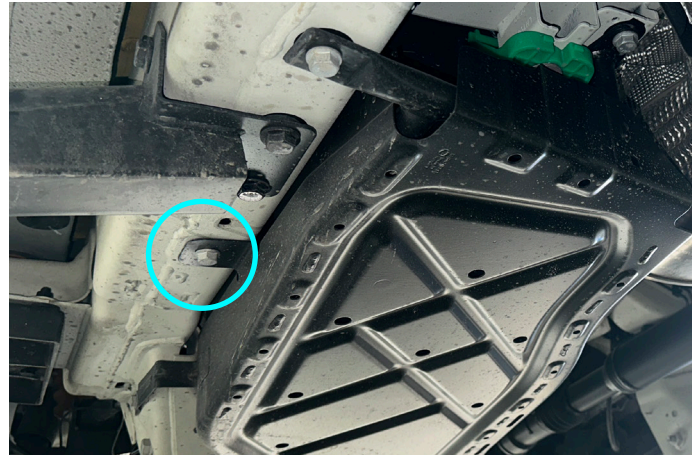

Fig. 6

6. Loosen side factory bolt as shown in fig.6



Fig. 7

7. Install the side bracket (item 4) and fix it using factory bolt as shown in fig.7

***Do not tighten yet.**

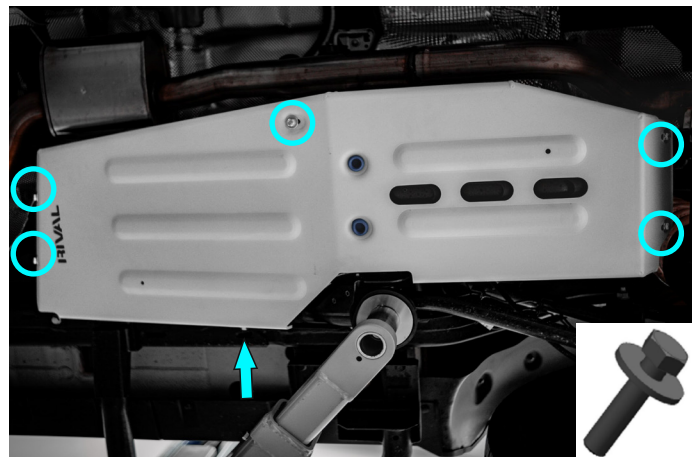

Fig. 8

8. Fix the fuel tank skid plate (item 1) using bolts M8x25 (item A) and washers 8 (item C) as shown in fig.8

***Tighten hardware after that.**

INSTALLATION PROCEDURE

Before operating a vehicle fitted with RIVAL Skid Plate:

- make sure all fittings are tightened;
- ensure the integrity of the structure and its components.

