

INSTALLATION MANUAL

PRODUCT: ENGINE SKID PLATE

APPLICATION: TOYOTA TACOMA (2024-PRESENT)
TOYOTA LC250 (2024-PRESENT)

PART NO: 2333.9571.2.6

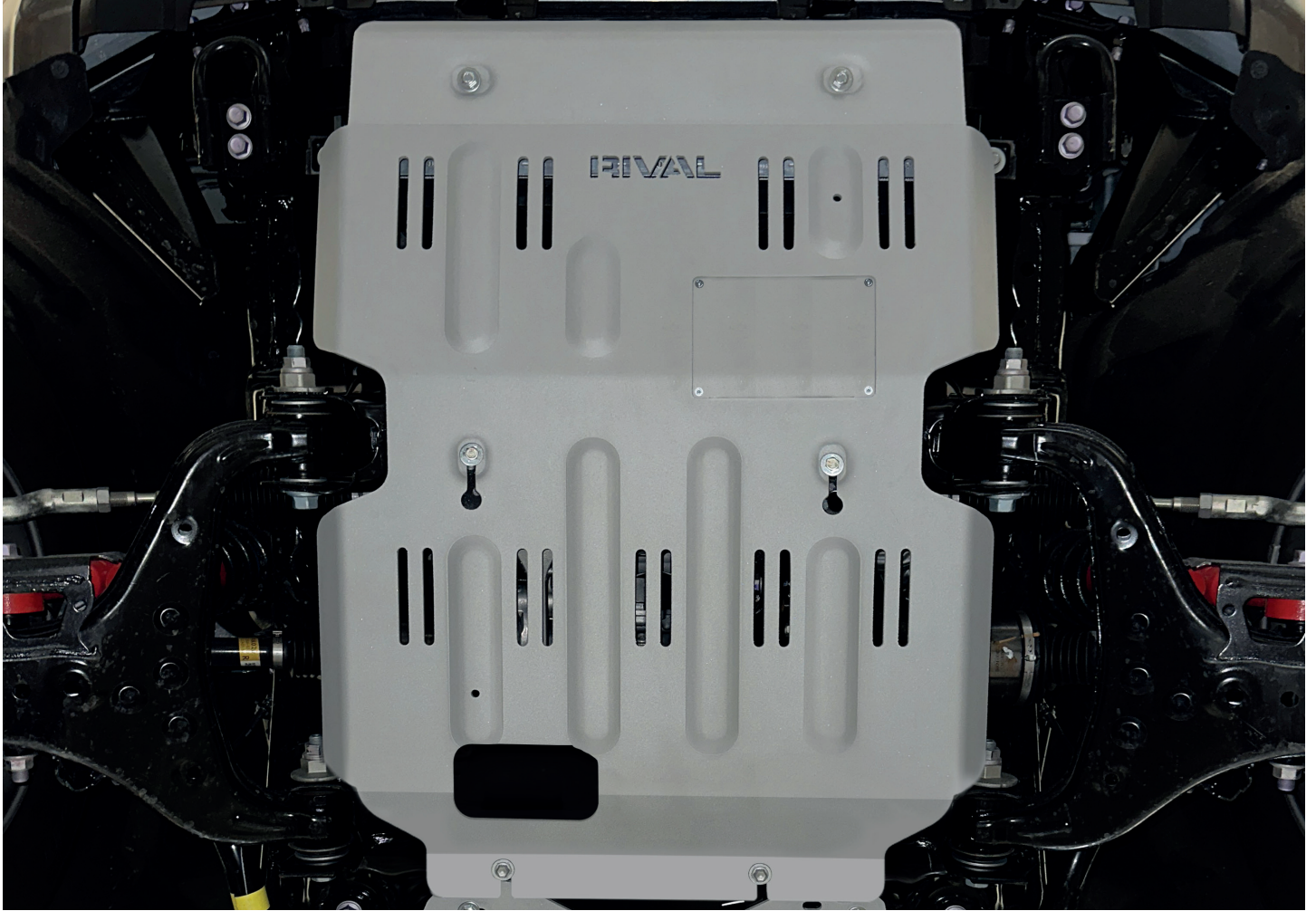

CAUTION!

To reduce the risk of serious injury or damage to property: Before you start installing and using this product, read the full instructions, pay special attention to the conditions of safe use and recommendations for installation! When installing or maintaining this product, it is necessary to use protective goggles. Check the integrity of the structure and the moment the fastening is tightened every 250 miles (400 kms) of mileage. Do not use this product if there is damage to the structure or fasteners!

NOTICE

Skid plate is an additional protection, but it can not guarantee to protect against all possible damage in collisions. When driving, be careful of objects and terrain that may damage sensitive parts of the vehicle.

ENGINE SKID PLATE

Part number 2333.9571.2.6

Suited to vehicle: TOYOTA TACOMA V-2.4, 2.4 Hybrid; AT; 4WD;
DoubleCab, XtraCab (2024-PRESENT)
TOYOTA LC250 V-2.4, 2.4 Hybrid, 2.7, 2.8D; AT;
4WD (2024-PRESENT)

Material: Aluminum



SAFETY NOTICE

- * The RIVAL skid plate is designed to complement the use and design of the specified vehicle under conditions specified by the vehicle manufacturer.
- * While driving the vehicle at any speed, collision with any other vehicle, animal or object must always be avoided.
- * Following any collision with any other vehicle, animal or object, the RIVAL skid plate and the vehicle must be inspected by a specialized or suitably qualified vehicle repairer for possible damage to the components and assemblies in order to confirm suitability for further use of the vehicle.
- * It is strongly recommended that you do not operate a vehicle with a damaged skid plate or its components. In the case of damage, please contact the nearest RIVAL dealer. Vehicle, or where the skid plate has been damaged, is extremely dangerous and must be avoided at all cost.

INSTALLATION NOTICE

- * The RIVAL skid plate must be mounted and affixed to the vehicle according to this installation manual.
- * Personal safety during the installation process must be adhered to at all times.
- * Do not install this skid plate on vehicle models other than those allowed in this manual.
- * Estimated time for installation: 1 hour.

REQUIRED TOOLS

- * Basic tool kit
- * Torque wrench

TORQUE SETTING

- * M8 - 24 H·m (17.7 lb/ft)

PARTS LISTING

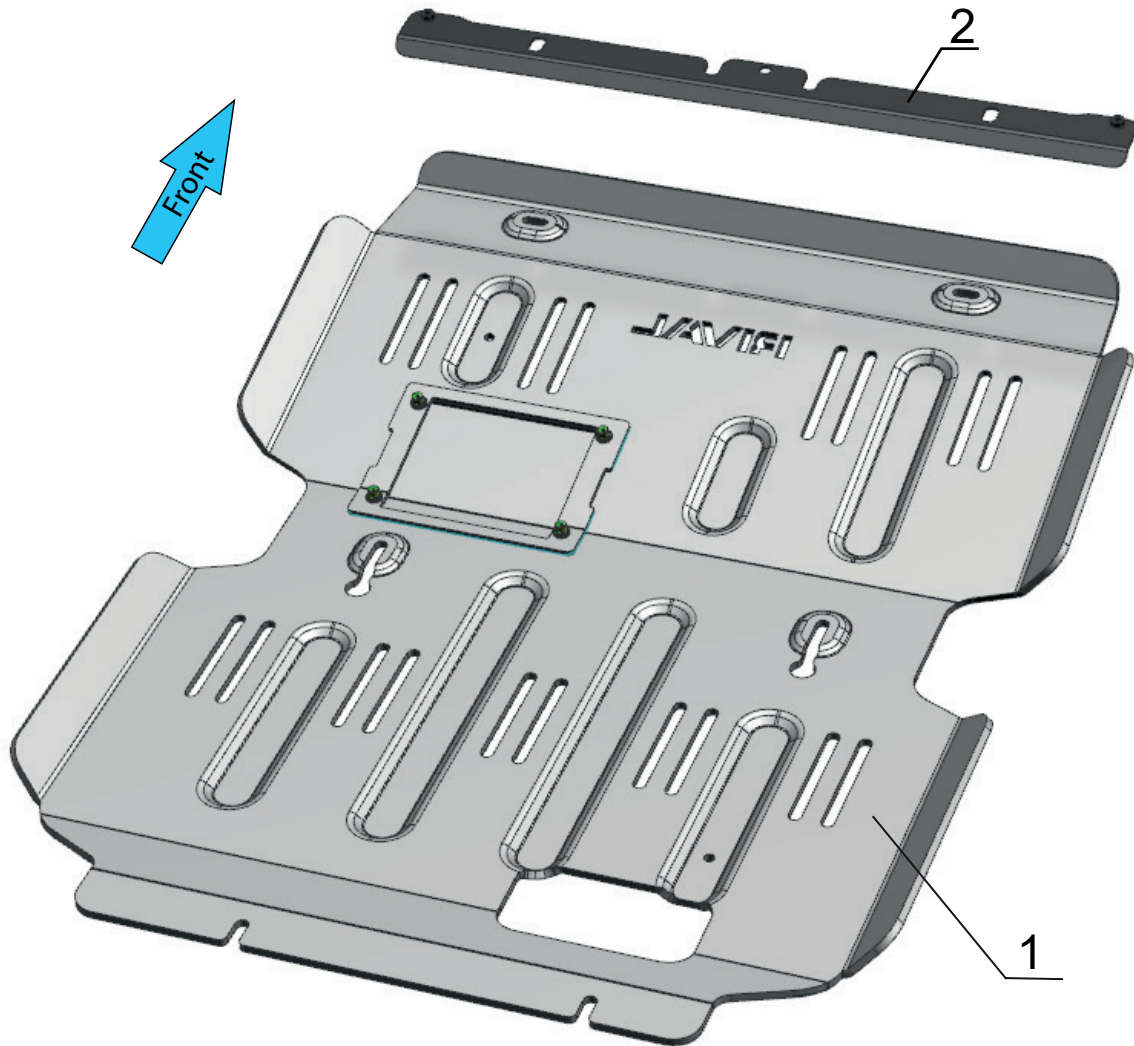

- 1. Engine skid plate.....Qty 1
- 2. Mounting bracket.....Qty 1

PARTS LISTING

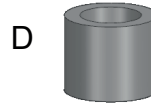
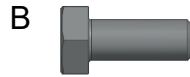
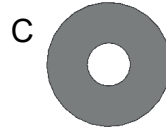
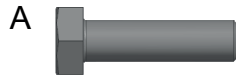

A. Bolt M8x40.....	Qty 2
B. Bolt M8x25.....	Qty 4
C. Washer M8.....	Qty 6
D. Spacer 15mm.....	Qty 2

INSTALLATION PROCEDURE

For Toyota LC250 (steps 1-6)

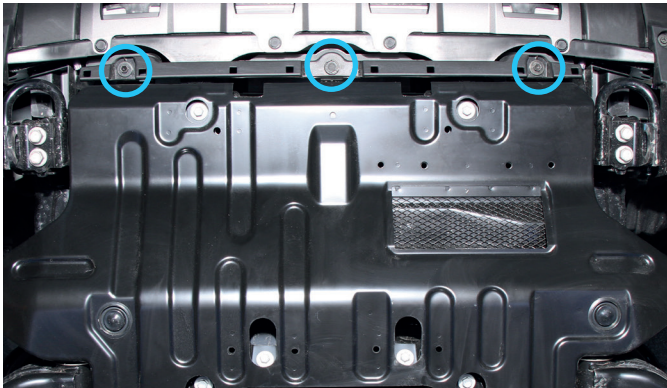

Fig. 1

1. Remove factory plastic cover as shown in fig.1.

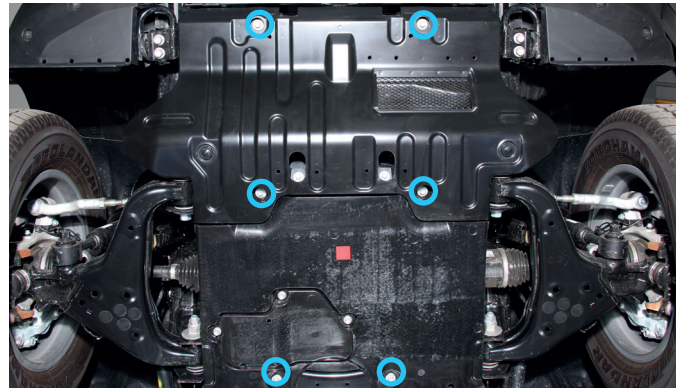

Fig. 2

2. Remove factory skid plates as shown in fig.2.

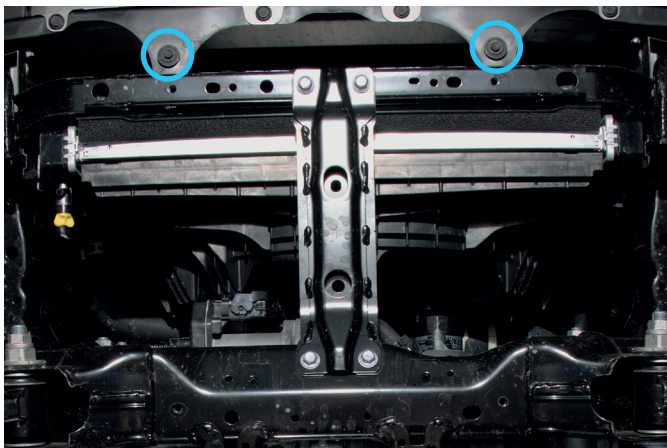

Fig. 3

3. Unscrew factory bolts as shown in fig.3.

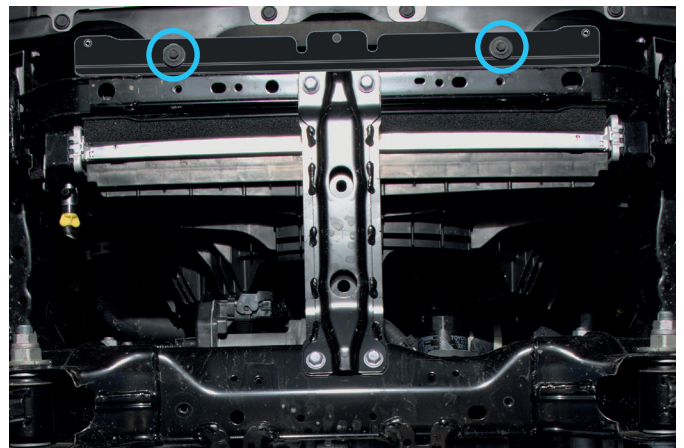

Fig. 4

4. Install mounting bracket (item 2) as close as possible to the factory bumper and fix it using factory bolts from step 3 as shown in fig.4.
***Tighten hardware after that.**

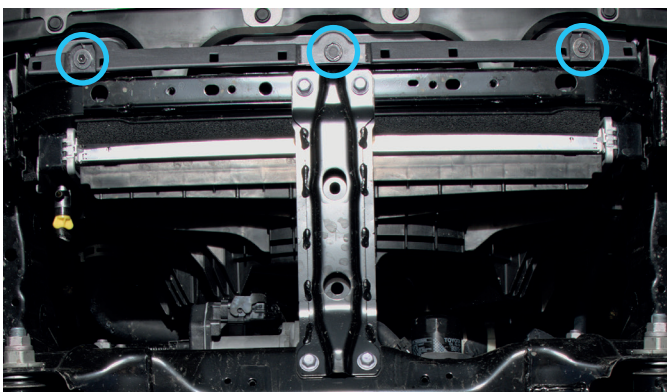

Fig. 5

5. Fix factory plastic cover to pre-installed mounting bracket (item 2) using factory bolts from step 1 as shown in fig.5.
***Tighten hardware after that.**

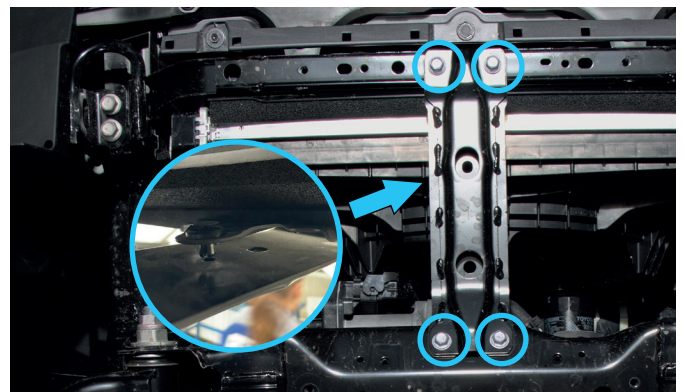

Fig. 6

6. Remove factory beam as shown in fig.6.

INSTALLATION PROCEDURE

For all vehicles (steps 7-10)

*If equipped, remove the factory skid plate or any other aftermarket skid plate.

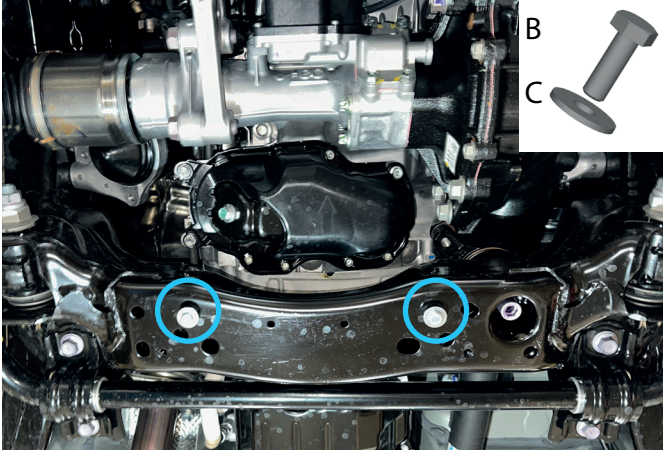

Fig. 7

7. Screw bolts M8x25 (item B) with washers M8 (item C) for 2-3 turns as shown in fig.7.

***Do not tighten yet.**

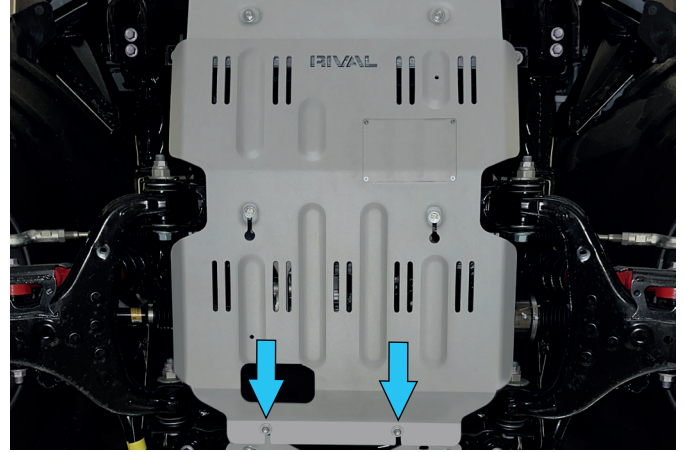

Fig. 8

8. Put the engine skid plate (item 1) on M8x25 bolts (item A) as shown in fig. 8.

***Do not tighten yet.**

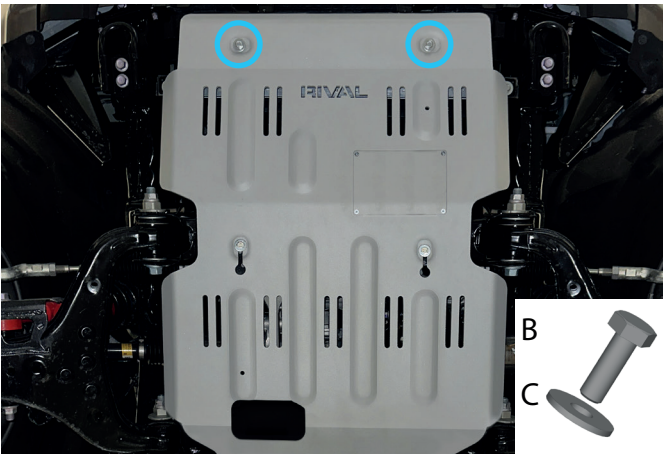

Fig. 9

9. Fix front part of engine skid plate using bolts M8x25 (item B) and washers M8 (item C) as shown in fig.9.

***Do not tighten yet.**

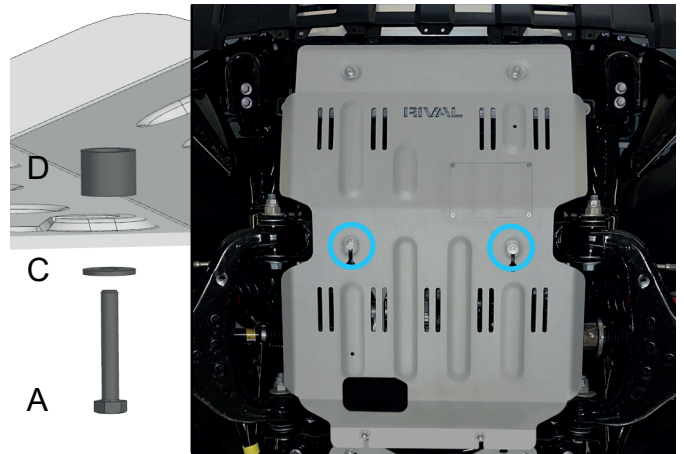

Fig. 10

10. Fix middle part of the engine skid plate using spacers 15mm (item D), bolts M8x40 (item A) and washers M8 (item C) as shown in fig.10.

***Tighten hardware after that.**

INSTALLATION PROCEDURE

Before operating a vehicle fitted with RIVAL Skid Plate:

- make sure all fittings are tightened;
- ensure the integrity of the structure and its components.

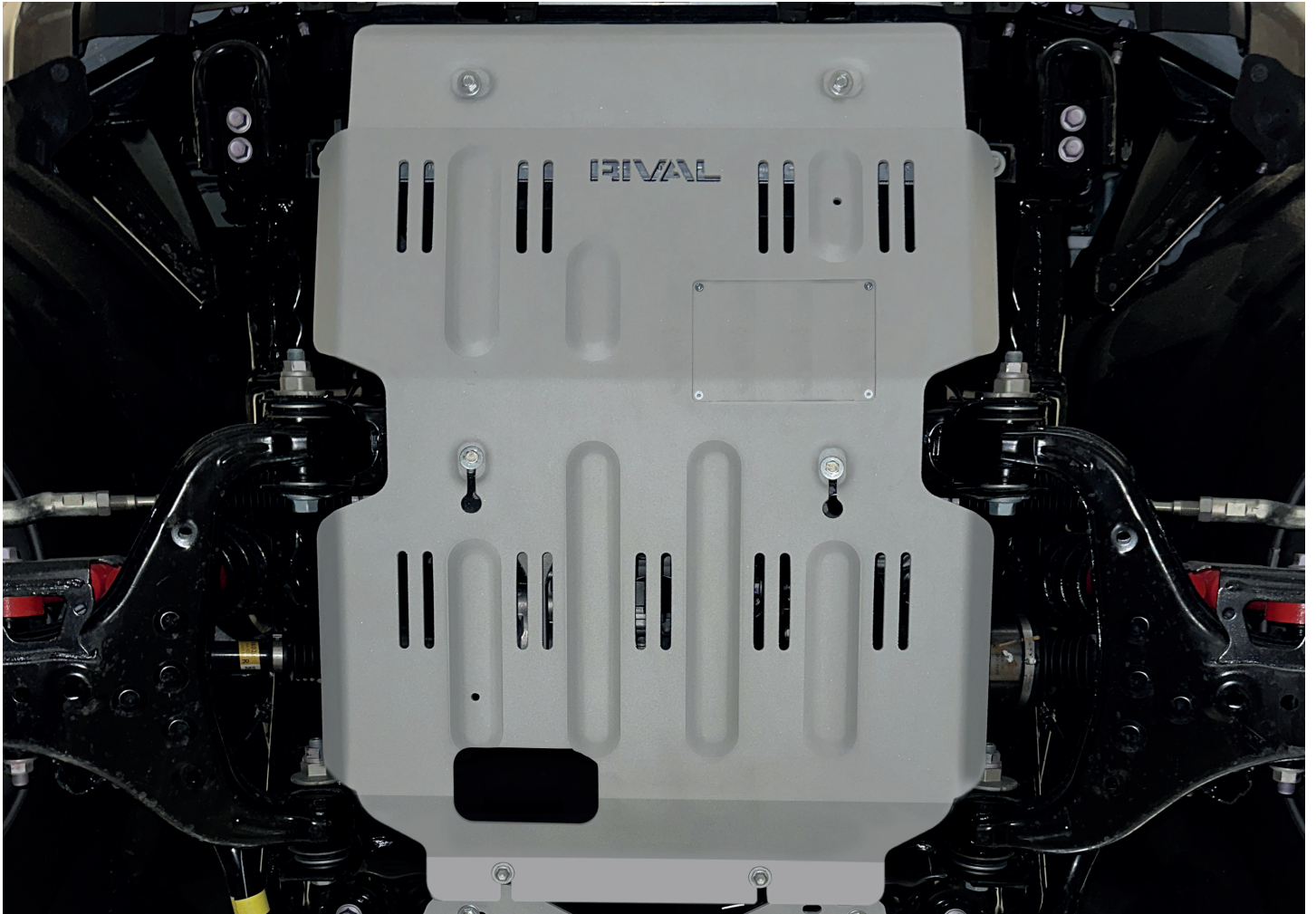

INSTALLATION MANUAL

PRODUCT: TRANSMISSION SKID PLATE

APPLICATION: TOYOTA LC250 (2024-PRESENT)

PART NO: 2333.9580.1.6



CAUTION!

To reduce the risk of serious injury or damage to property: Before you start installing and using this product, read the full instructions, pay special attention to the conditions of safe use and recommendations for installation! When installing or maintaining this product, it is necessary to use protective goggles. Check the integrity of the structure and the moment the fastening is tightened every 250 miles (400 kms) of mileage. Do not use this product if there is damage to the structure or fasteners!

NOTICE

Skid plate is an additional protection, but it can not guarantee to protect against all possible damage in collisions. When driving, be careful of objects and terrain that may damage sensitive parts of the vehicle.

TRANSMISSION SKID PLATE

Part number: 2333.9580.1.6

Suited to vehicle: Toyota LC250 (2024-Present)
V-2.8D; AT; 4WD

Material: Aluminum



SAFETY NOTICE

- * The RIVAL skid plate is designed to complement the use and design of the specified vehicle under conditions specified by the vehicle manufacturer.
- * While driving the vehicle at any speed, collision with any other vehicle, animal or object must always be avoided.
- * Following any collision with any other vehicle, animal or object, the RIVAL skid plate and the vehicle must be inspected by a specialized or suitably qualified vehicle repairer for possible damage to the components and assemblies in order to confirm suitability for further use of the vehicle.
- * It is strongly recommended that you do not operate a vehicle with a damaged skid plate or its components. In the case of damage, please contact the nearest RIVAL dealer. Vehicle, or where the skid plate has been damaged, is extremely dangerous and must be avoided at all cost.

INSTALLATION NOTICE

- * The RIVAL skid plate must be mounted and affixed to the vehicle according to this installation manual.
- * Personal safety during the installation process must be adhered to at all times.
- * Do not install this skid plate on vehicle models other than those allowed in this manual.
- * Estimated time for installation: 1 hour.

REQUIRED TOOLS

- * Basic tool kit
- * Torque wrench

TORQUE SETTING

- * M8 - 24 N·m (17.7 lb/ft)

PARTS LISTING

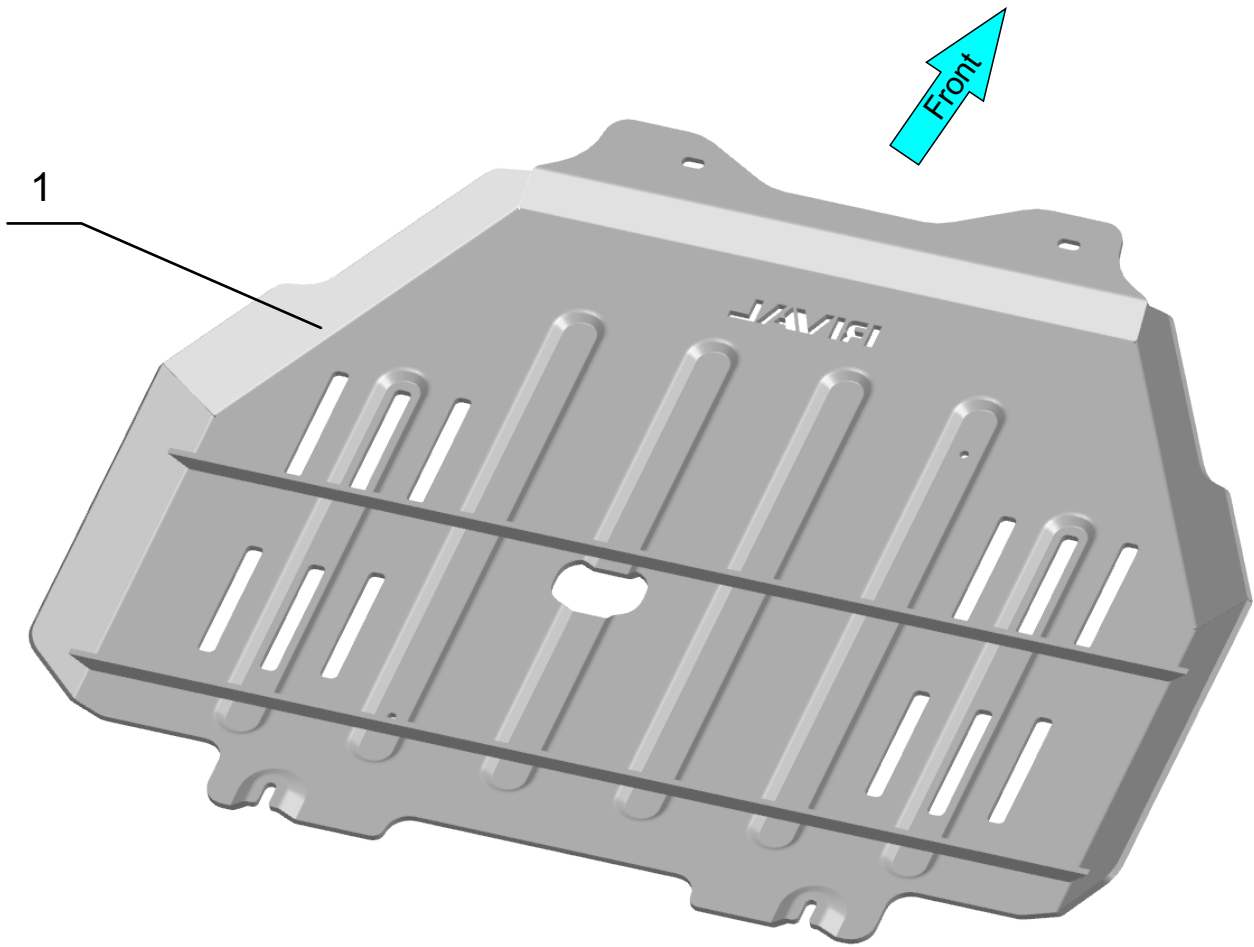

1. Skid plate..... Qty 1

PARTS LISTING

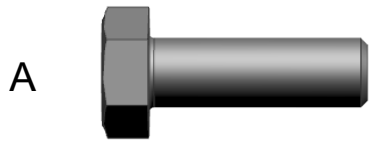

A. Bolt M8x25.....	Qty 4
B. Washer M8.....	Qty 4
C. Insert nut M8.....	Qty 2

INSTALLATION PROCEDURE

***If equipped, remove factory skid plate or any other aftermarket skid plate.**

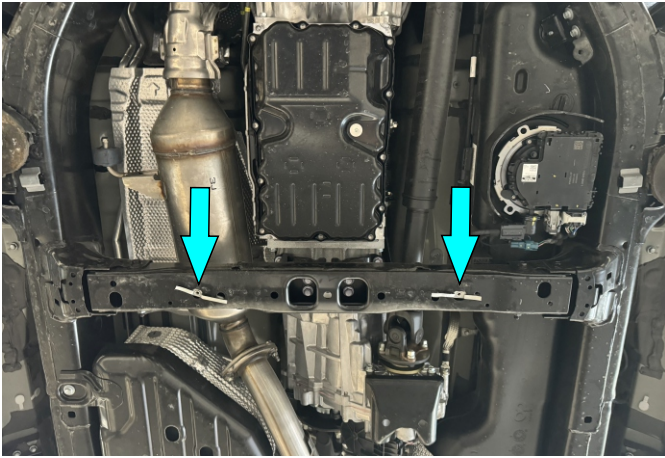

Fig. 1

1. Install insert nuts M8 (item C) as shown in fig. 1.

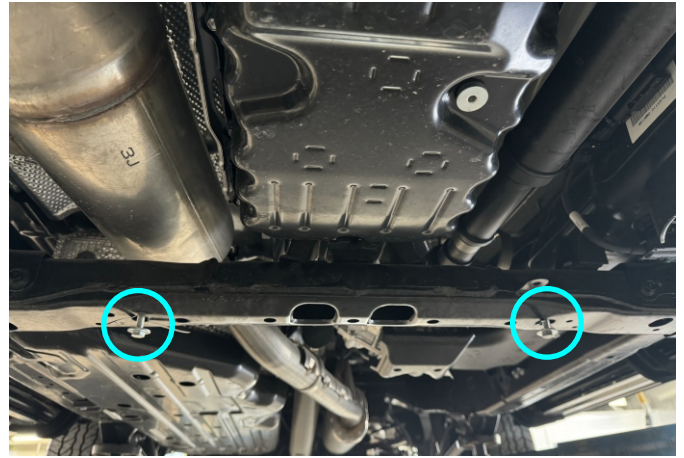

Fig. 2

2. Loosely insert supplied bolts M8x25 with washers M8 (items A, B) to insert nuts M8 as shown in fig. 2.

***Do not tighten yet.**

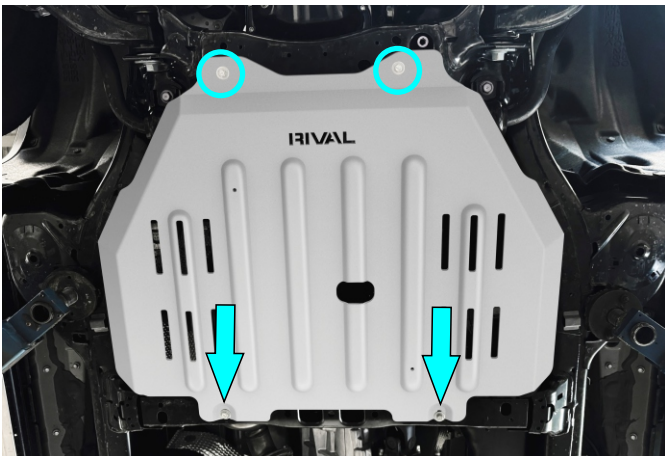

Fig. 3

3. Slide rear part of transmission skid plate under previously installed bolts M8. After that secure front part using bolts M8x25 and washers M8 (items A, B) as shown in fig. 3.

***Once all bolts are inserted, check skid plate alignment and tighten all previously installed hardware.**

INSTALLATION PROCEDURE

Before operating a vehicle fitted with RIVAL Skid Plate:

- make sure all fittings are tightened;
- ensure the integrity of the structure and its components.



INSTALLATION MANUAL

PRODUCT: TRANSFER CASE SKID PLATE

APPLICATION: TOYOTA LC250 (2024-PRESENT)

PART NO: 2333.9582.1.6



CAUTION!

To reduce the risk of serious injury or damage to property: Before you start installing and using this product, read the full instructions, pay special attention to the conditions of safe use and recommendations for installation! When installing or maintaining this product, it is necessary to use protective goggles. Check the integrity of the structure and the moment the fastening is tightened every 250 miles (400 kms) of mileage. Do not use this product if there is damage to the structure or fasteners!

NOTICE

Skid plate is an additional protection, but it can not guarantee to protect against all possible damage in collisions. When driving, be careful of objects and terrain that may damage sensitive parts of the vehicle.

TRANSFER CASE SKID PLATE

Part number: 2333.9582.1.6

Suited to vehicle: Toyota LC250 (2024-Present),
V-2.8D; AT; 4WD

Material: Aluminum



SAFETY NOTICE

- * The RIVAL skid plate is designed to complement the use and design of the specified vehicle under conditions specified by the vehicle manufacturer.
- * While driving the vehicle at any speed, collision with any other vehicle, animal or object must always be avoided.
- * Following any collision with any other vehicle, animal or object, the RIVAL skid plate and the vehicle must be inspected by a specialized or suitably qualified vehicle repairer for possible damage to the components and assemblies in order to confirm suitability for further use of the vehicle.
- * It is strongly recommended that you do not operate a vehicle with a damaged skid plate or its components. In the case of damage, please contact the nearest RIVAL dealer. Vehicle, or where the skid plate has been damaged, is extremely dangerous and must be avoided at all cost.

INSTALLATION NOTICE

- * The RIVAL skid plate must be mounted and affixed to the vehicle according to this installation manual.
- * Personal safety during the installation process must be adhered to at all times.
- * Do not install this skid plate on vehicle models other than those allowed in this manual.
- * Estimated time for installation: 1 hour.

REQUIRED TOOLS

- * Basic tool kit
- * Torque wrench

TORQUE SETTING

- * M8 - 24 N·m (17.7 lb/ft)

PARTS LISTING

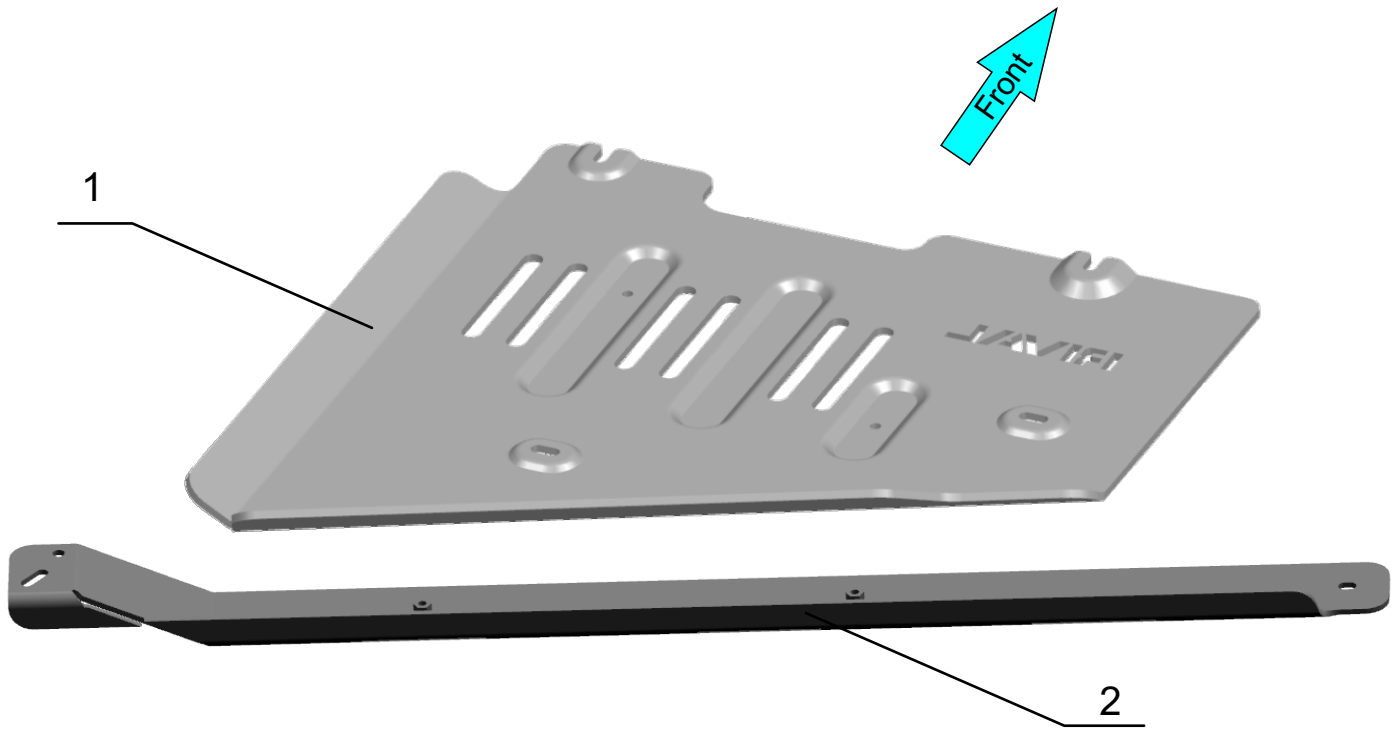

- 1. Skid plate.....Qty 1
- 2. Crossmember.....Qty 1

PARTS LISTING

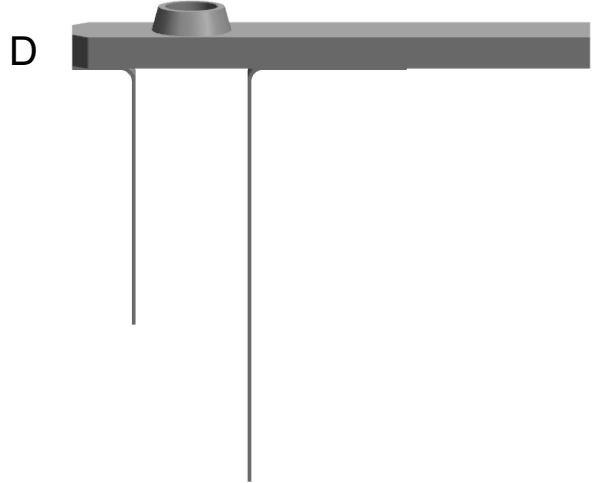
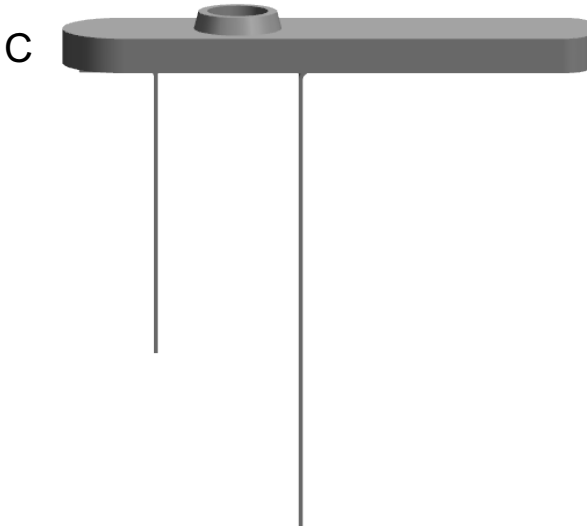
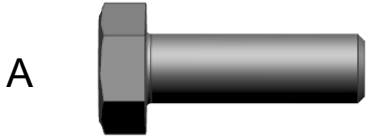

- A. Bolt M8x25 (2 pc. preinstalled).....Qty 6
- B. Washer M8 (2 pc. preinstalled).....Qty 6
- C. Insert nut M8x70.....Qty 2
- D. Insert nut M8x65.....Qty 2

INSTALLATION PROCEDURE

***If equipped, remove factory skid plate or any other aftermarket skid plate.**

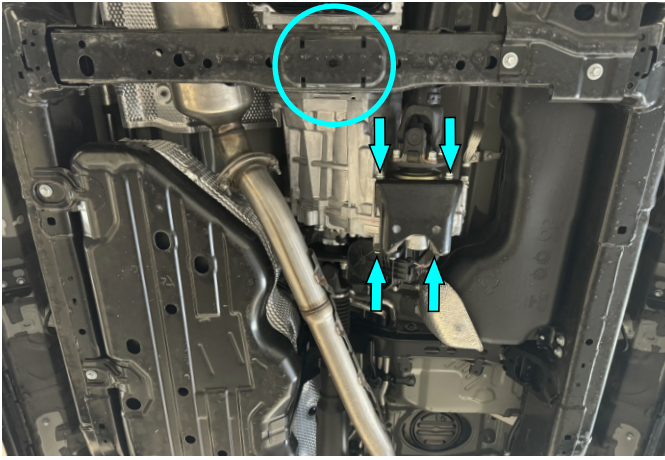

Fig. 1

1. Remove plastic pad and factory cover as shown in fig. 1.

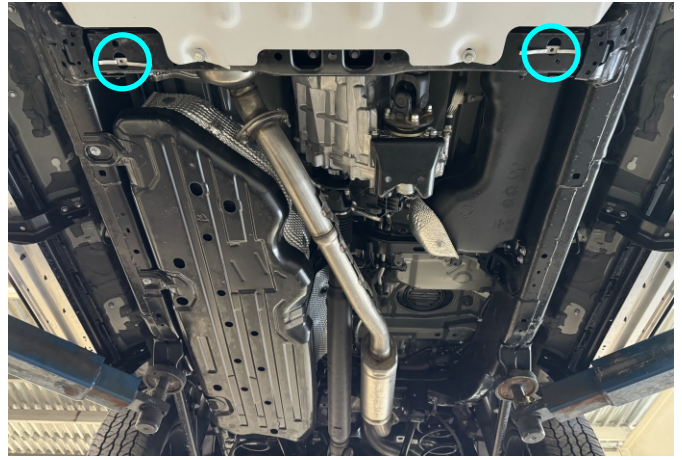

Fig. 2

2. Install insert nuts M8x70 (item C) as shown in fig. 2.

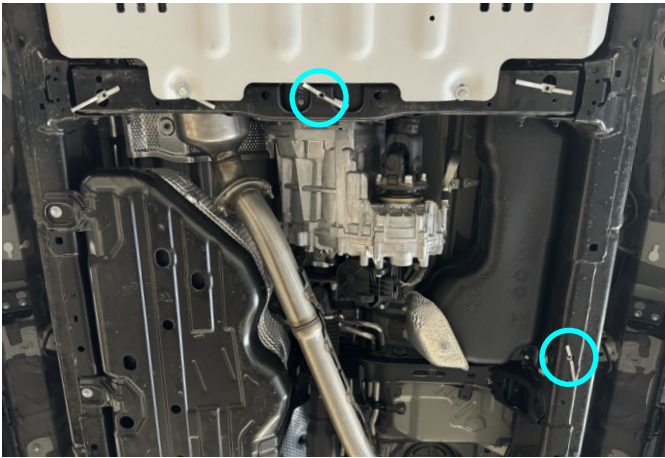

Fig. 3

3. Install insert nuts M8x65 (item D) as shown in fig. 3.

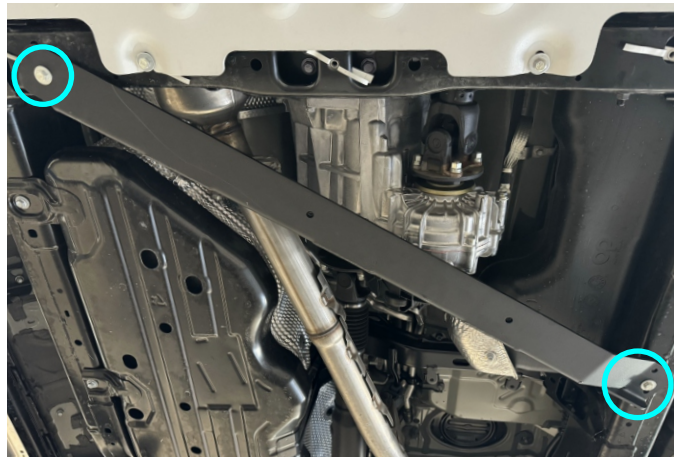

Fig. 4

4. Secure crossmember (item 2) using bolts M8x25 and washers M8 (items A, B) as shown in fig. 4.

***Do not tighten yet.**

INSTALLATION PROCEDURE



Fig. 5

5. Loosely insert supplied bolts M8x25 with washers M8 (items A, B) to insert nuts M8 as shown in fig. 5.

***Do not tighten yet.**

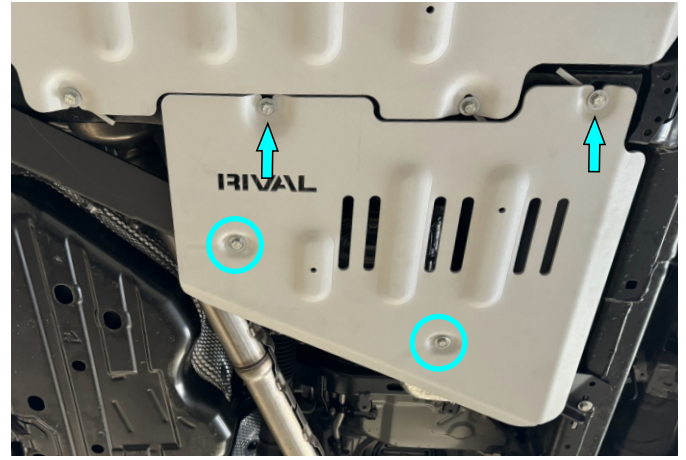

Fig. 6

6. Slide front part of skid plate under previously installed bolts M8. After that secure rear part using bolts M8x25 and washers M8 (items A, B) as shown in fig. 6.

***Once all bolts are inserted, check skid plate alignment and tighten all previously installed hardware.**

INSTALLATION PROCEDURE

Before operating a vehicle fitted with RIVAL Skid Plate:

- make sure all fittings are tightened;
- ensure the integrity of the structure and its components.

