

INSTALLATION MANUAL

PRODUCT: FRONT ALUMINUM BUMPER

APPLICATION: VOLKSWAGEN AMAROK (2023 - PRESENT)

PART NO: 2D.5813.1-NL



CAUTION!

To reduce the risk of serious injury or damage to property: Before you start installing and using this product, read the full instructions, pay special attention to the conditions of safe use and recommendations for installation! When installing or maintaining this product, it is necessary to use protective goggles. Check the integrity of the structure and the moment the fastening is tightened every 250 miles (400 kms) of mileage. Do not use this product if there is damage to the structure or fasteners!

NOTICE

Skid plate is an additional protection, but it can not guarantee to protect against all possible damage in collisions. When driving, be careful of objects and terrain that may damage sensitive parts of the vehicle.

FRONT BUMPER

Part number: 2D.5813.1-NL

Suited to vehicle: Volkswagen Amarok (2023-Present)

Material: Aluminum / steel



SAFETY NOTICE

- * The RIVAL Bumper is designed to compliment the use and design of the specified vehicle under conditions specified by the vehicle manufacturer.
- * While driving the vehicle at any speed, collision with any other vehicle, animal or object must always be avoided.
- * Following any collision with any other vehicle, animal or object, the RIVAL Bumper and the vehicle must be inspected by a specialized or suitably qualified vehicle repairer for possible damage to the components and assemblies in order to confirm suitability for further use of the vehicle.
- * It is strongly recommended that you do not operate a vehicle with a damaged bumper or its components. In the case of damage, please contact the nearest RIVAL dealer. Vehicle, or where the bumper has been damaged, is extremely dangerous and must be avoided at all cost.
- * The operation of a vehicle where the bumper is not properly attached and fastened to the vehicle, or where the bumper has been damaged, is extremely dangerous and must be avoided at all cost.
- * It is recommended that you carry out regular inspections of all the bumper elements such as all bolts, wires, connectors.
- * A winch with a pull capacity of up to and including 12000 lb can be installed with the RIVAL Bumper. It is not advisable to exceed this pulling capacity since damage, injury or death may occur where the 12000lb recommended capacity is exceeded. The Rival bumper provides standard 4 1/2"x10" mounting holes.

INSTALLATION NOTICE

- * Personal safety during the installation process must be adhered to at all times.
- * Estimated time for installation: 4 hours.
- * The RIVAL Bumper must be mounted and affixed to the vehicle according to this installation manual and the use of personal safety equipment is highly recommended.
- * Do not install this bumper on vehicle models other than those allowed in this manual.
- * Check state and local highway safety laws regarding permitted bumper types and heights.

NOTE: if the bumper is to be color coded it is advised to test fit before color coding. RIVAL is not liable for color coding cost, it is the installers' responsibility to check the fitment and alignment before color coding.

ADR69 AND AIR BAG SYSTEM

The Rival bumper has been tested and certified to be compatible with ADR69 and will not affect the operation of the Air bag System on this vehicle. This product or mounting brackets must not be modified in any way, and must be fitted in accordance with the installation instructions.

REQUIRED TOOLS

- * Basic tool kit
- * Torque wrench
- * Crosspoint and flat head screwdriver
- * Marker
- * Angle grinder
- * Drill

TORQUE SETTING

- * M6 - 9 N·m
- * M8 - 24 N·m
- * M10 - 44 N·m
- * M12 - 77 N·m

TECHNICAL INFORMATION

WINCH INSTALLATION

A winch with a pull capacity of up to 12000 lbs can be installed with the RIVAL Bumper. It is not advisable to exceed this pulling capacity since damage, injury or death may occur where the 12000 lbs recommended capacity is exceeded.

Winch measurements:

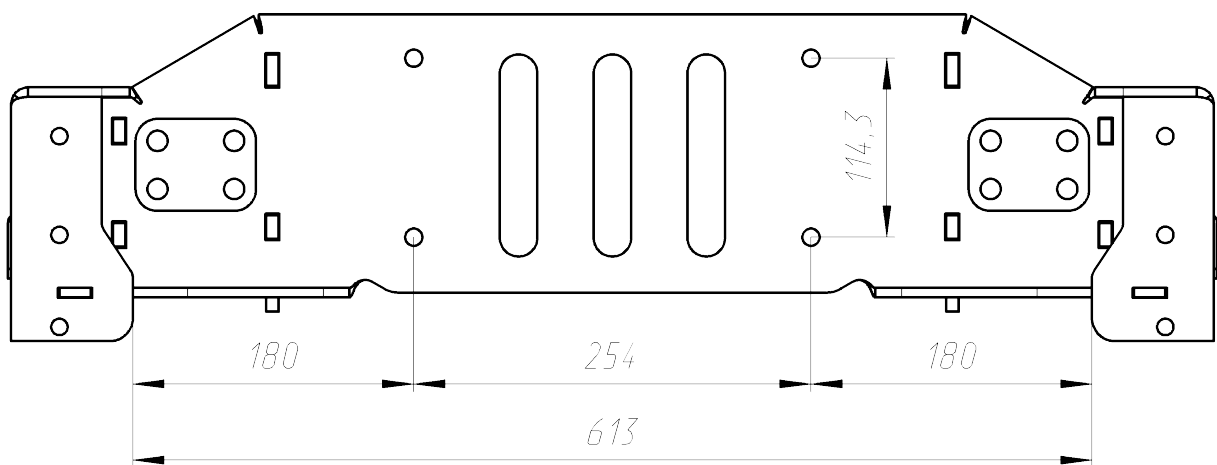

Winch size limits:

L 613 x W 175 mm x H 210 mm

LIGHTS

The bumper provides for the light mounting points.

Overall dimensions of the lights under installation:

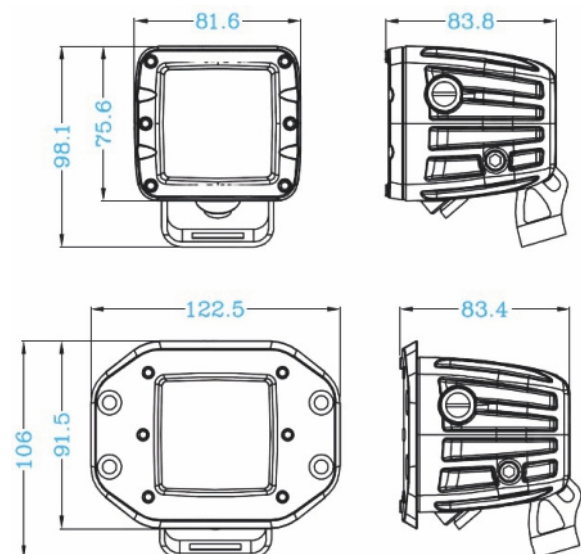

TECHNICAL INFORMATION

RECOVERY POINTS



WARNING!

Do not exceed the Working Load Limit of these recovery points or shackle.

INSPECTION AND SAFETY

Recovery of stuck vehicles can be dangerous. Always inspect the shackle and recovery points before each use. Do not use if there are visible signs of damage or wear including cracking (or elongation). Always stay a safe distance away from the recovery area - at least 1.5 times the length of the recovery strap. Incorrect use of receivers equipment can result in serious injury or death.

Always use recovery points as a matched pair teamed with an equalising bridle during any recovery situation.

Please attach this "Warning" label to the door aperture.

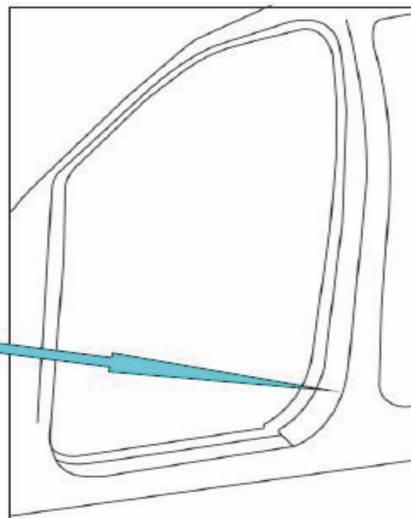

PARTS LISTING

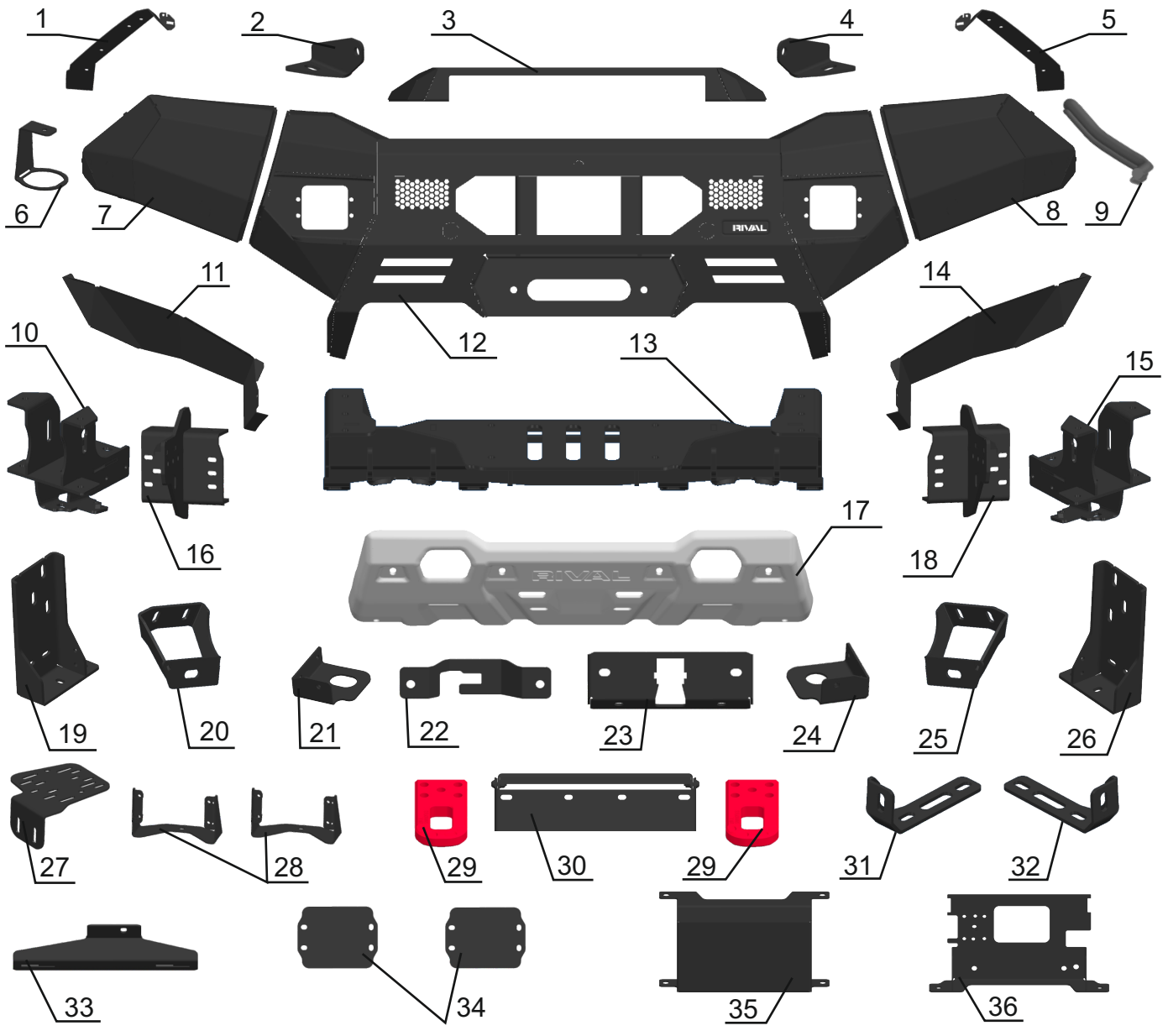

1. Right grille bracket.....	Qty 1	19. Right bumper bracket.....	Qty 1
2. Right lightbar bracket.....	Qty 1	20. Right adjustment bracket.....	Qty 1
3. Lightbar cap.....	Qty 1	21. Right intercooler bracket.....	Qty 1
4. Left lightbar bracket.....	Qty 1	22. Camera clamp.....	Qty 1
5. Left grille bracket.....	Qty 1	23. Camera bracket.....	Qty 1
6. Wrench for mounting parking sensors....	Qty 1	24. Left intercooler bracket.....	Qty 1
7. Right end cap.....	Qty 1	25. Left adjustment bracket.....	Qty 1
8. Right reinforcing bracket.....	Qty 1	26. Left bumper bracket.....	Qty 1
9. Weatherstrip.....	Qty 2	27. Winch control box bracket.....	Qty 1
10. Right reinforcing bracket.....	Qty 1	28. LED bracket.....	Qty 2
11. Right flap.....	Qty 1	29. Recovery point.....	Qty 2
12. Bumper body.....	Qty 1	30. License plate bracket.....	Qty 1
13. Winch bracket.....	Qty 1	31. Right fairlead bracket.....	Qty 1
14. Left flap.....	Qty 1	32. Left fairlead bracket.....	Qty 1
15. Left reinforcing bracket.....	Qty 1	33. Central grille bracket.....	Qty 1
16. Right frame bracket.....	Qty 1	34. LED light cap.....	Qty 2
17. Bash plate.....	Qty 1	35. Radar cap.....	Qty 1
18. Left frame bracket.....	Qty 1	36. Radar bracket.....	Qty 1

PARTS LISTING

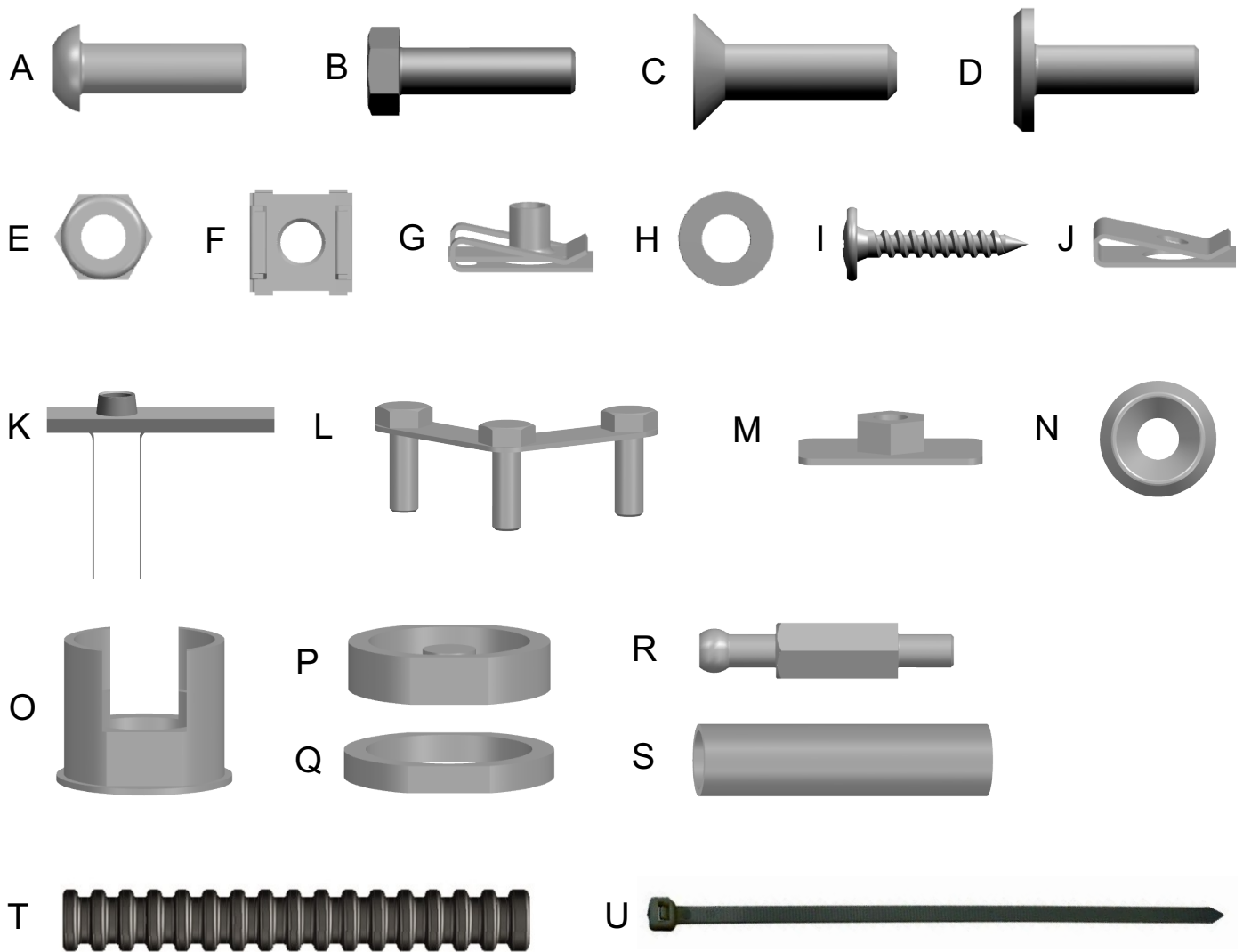

A1. Screw M6x1x16.....	Qty 2	H2. Washer M8.....	Qty 56
A2. Screw M6x1x20.....	Qty 33	H3. Washer M10.....	Qty 34
B1. Bolt M8x1.25x30.....	Qty 30	H4. Washer M12.....	Qty 36
B2. Bolt M10x1.5x30.....	Qty 14	I. Screw.....	Qty 10
B3. Bolt M12x1.75x50.....	Qty 16	J. U-nut.....	Qty 10
B4. Bolt M12x1.75x110.....	Qty 2	K. Insert nut M10x65x20 with wires.....	Qty 6
C. Screw M10x1.5x30.....	Qty 6	L. Insert nut 3xM10x1.5.....	Qty 2
D. Screw M6x1x20.....	Qty 6	M. Insert nut M10x43x30.....	Qty 2
E1. Nut M3x0.5.....	Qty 4	N. Washer M10.....	Qty 6
E2. Nut M6x1.....	Qty 21	O. Parking sensor holder.....	Qty 8
E3. Nut M8x1.25.....	Qty 26	P. Clamp of parking sensor.....	Qty 8
E4. Nut M10x1.5.....	Qty 20	Q. Nut of parking sensor.....	Qty 8
E5. Nut M12x1.75.....	Qty 18	R. Radar mounting pin.....	Qty 2
F. Cage nut M8x1.25.....	Qty 4	S. Spacer.....	Qty 2
G. Cage nut M6x1.....	Qty 12	T. Corrugated pipe.....	Qty 1
H1. Washer M6.....	Qty 55	U. Cable tie.....	Qty 15

INSTALLATION PROCEDURE

Preparation for installation



Fig.1

1. Open the hood. Disconnect terminal “-” from the vehicle battery (fig.1).

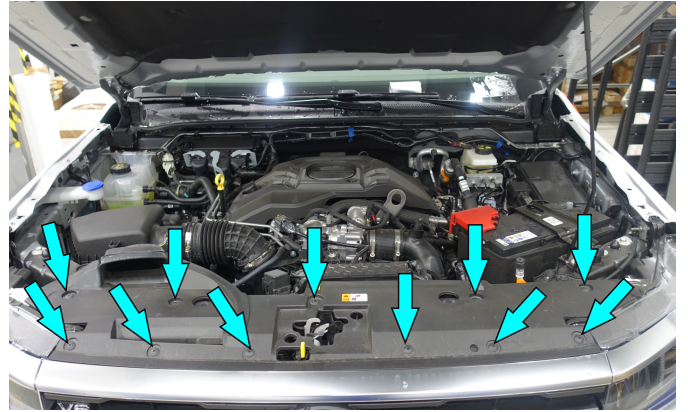

Fig.2

2. Release the phillips head clips to remove the top cover (fig. 2).

***Set aside for re-use later on.**



Fig.3

3. Unscrew factory bolts (fig.3).

***Set aside for re-use later on.**

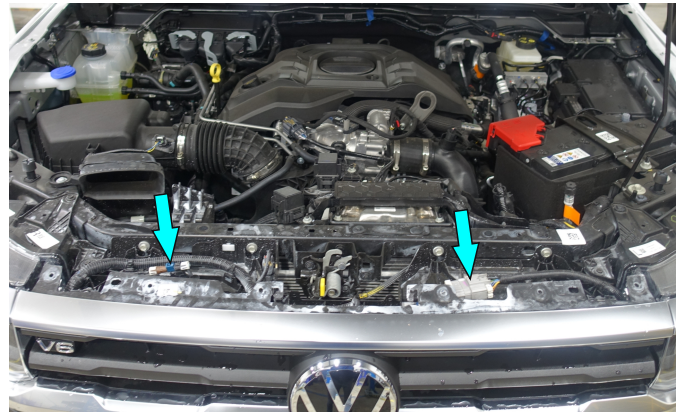

Fig.4

4. Disconnect factory wiring (fig.4).

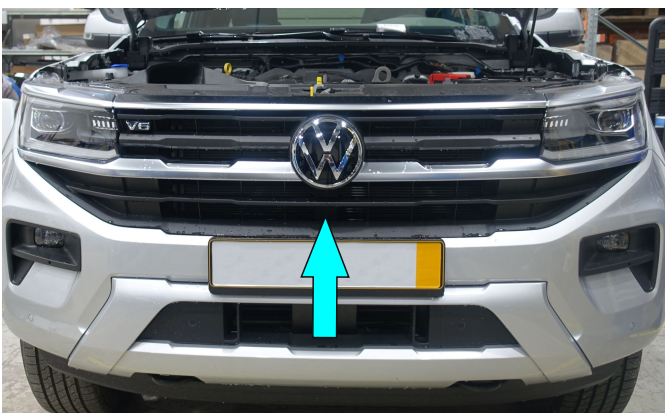

Fig.5

5. Remove radiator grille (fig.5).

***Set aside for re-use later on.**

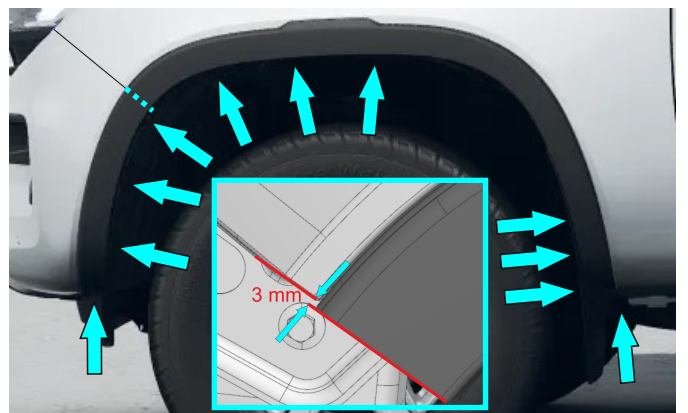

Fig.6

6. Mark a cutting line as shown in fig 6. Remove plastic clips and factory bolts to take off factory fenders.

INSTALLATION PROCEDURE

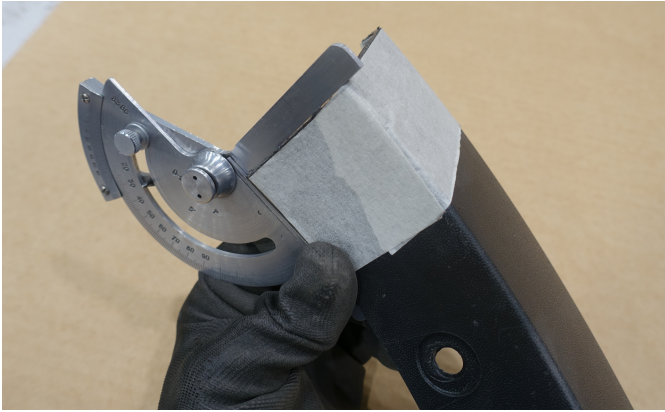

Fig.7

7. Before cutting, make sure that marked cutting line is perpendicular to edge of fender. After that cut plastic fenders using a jig-saw. (fig.7).



Fig.8

8. Install factory plastic fenders and secure them using factory hardware (fig.8).



Fig.9

9. Remove factory clips and remove the hatch (fig.9).

***Set aside for re-use later on.**



Fig.10

10. Unscrew factory bolts through holes from step 9 (fig.10).

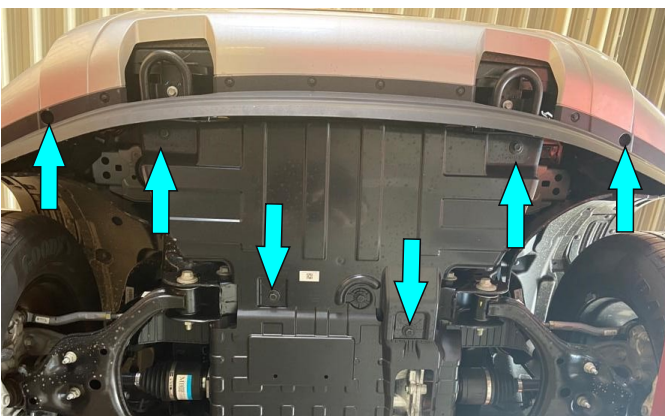

Fig.11

11. Unscrew bolts, remove factory skid plate (fig.11).

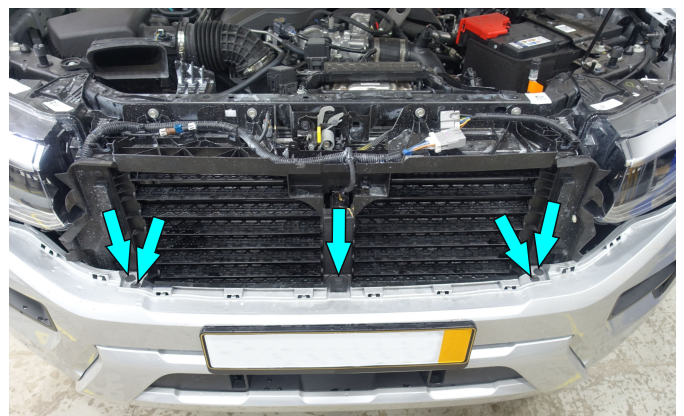

Fig.12

12. Remove plastic clips, unscrew bolts and remove factory bumper (fig.12).

INSTALLATION PROCEDURE

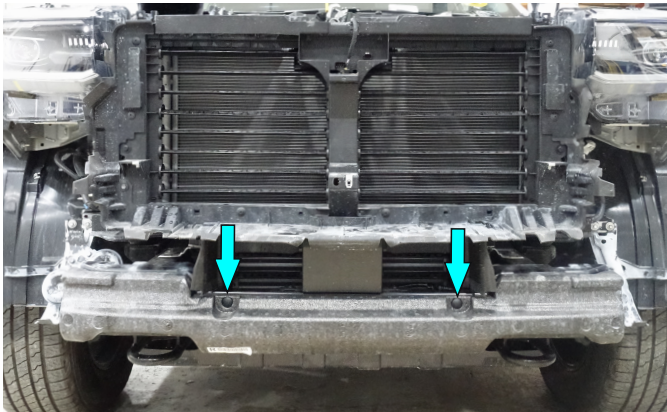

Fig.13

13. Remove plastic clips and polyfoam damper (fig.13).

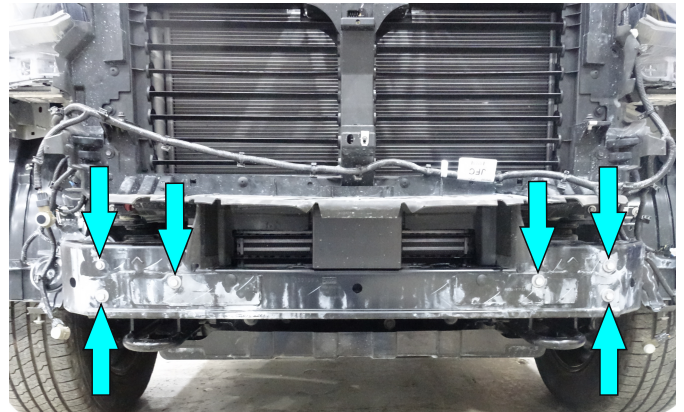

Fig.14

14. Unscrew bolts and remove factory crossmember (fig. 14).

If your vehicle is not fitted with radar, skip steps 15-16

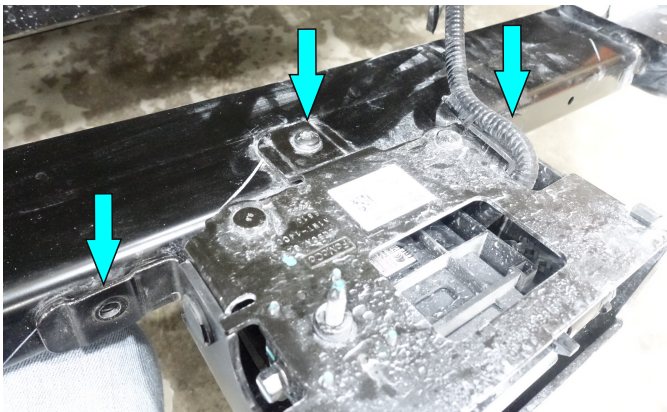

Fig.15

15. Unscrew factory bolts (fig.15).

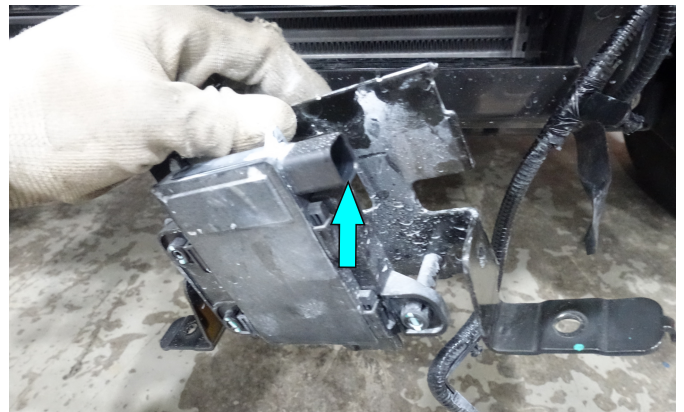

Fig.16

16. Remove the radar cover, unplug an electronic connector (fig.16).

***Set aside for re-use later on.**

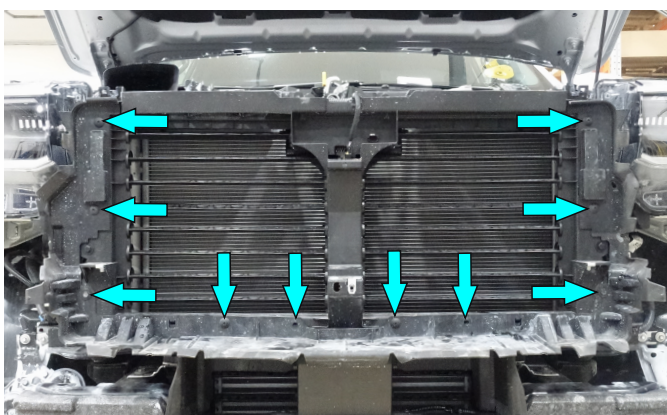

Fig.17

17. Remove factory bolts and clips. Next, remove factory plastic covers (fig.17).

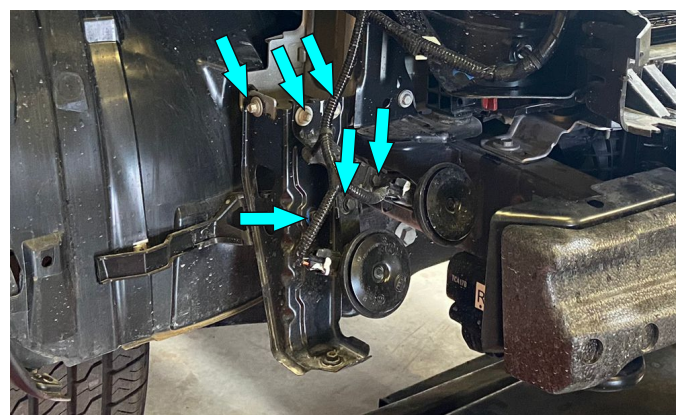

Fig.18

18. Unscrew factory bolts and remove bracket on both sides of the vehicle (fig.18).

***Set aside for re-use later on.**

INSTALLATION PROCEDURE

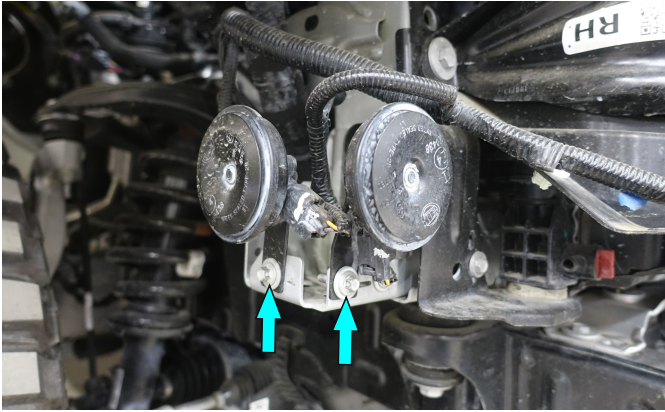

Fig.19

19. Install factory horn as shown in fig.19 and secure it using factory bolts.

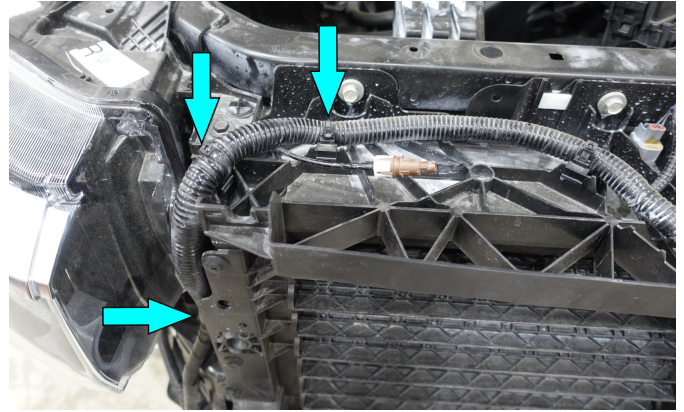

Fig.20

20. Cut the cable ties (fig. 20).
***If your vehicle is not fitted with front camera, skip steps 20-22.**

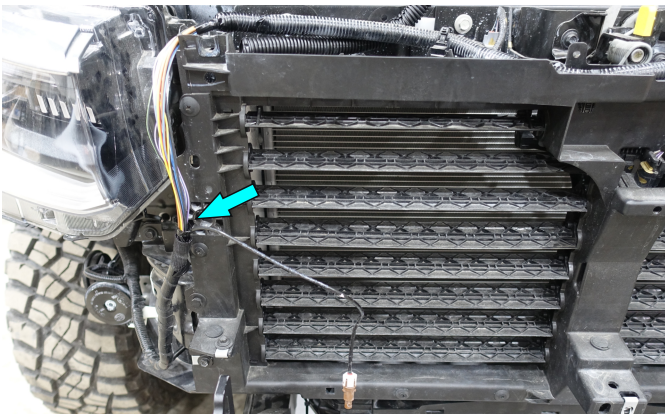

Fig.21

21. Remove corrugated pipe and pull out camera wiring and camera pipe.

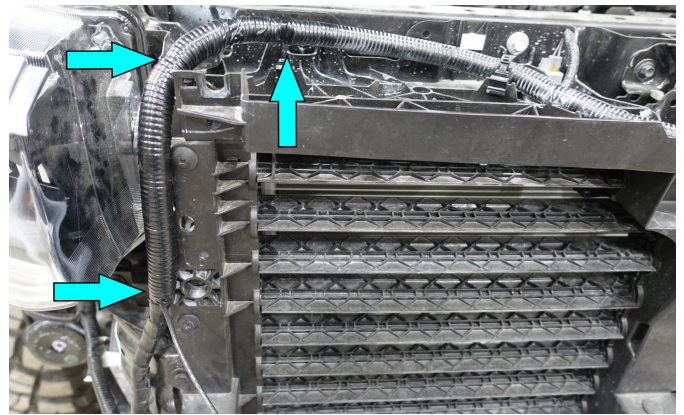

Fig.22

22. Return corrugated pipe, secure wiring using cable ties (item U). Insert corrugated pipe (item T) on camera wiring, insulate the wiring harness.

If your vehicle is not fitted with radar, skip steps 23-24

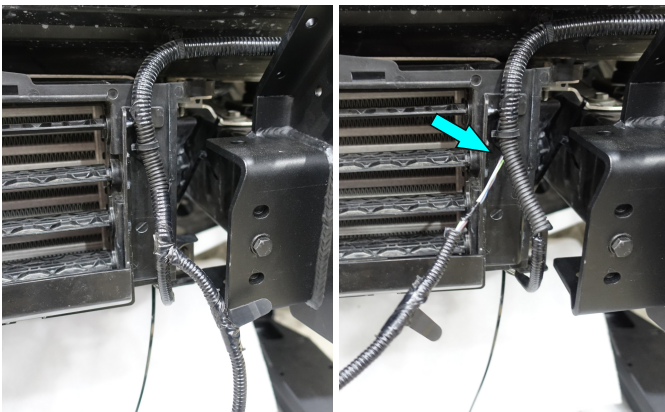

Fig.23

23. Remove insulation from the wiring. Pull the radar wiring out.

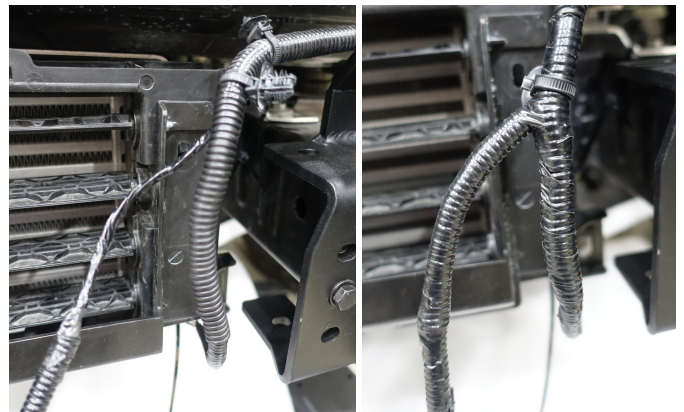

Fig.24

24. Insulate the wiring. Insert corrugated pipe (item T) on radar wiring and insulate it.

INSTALLATION PROCEDURE

Winch bracket installation procedure

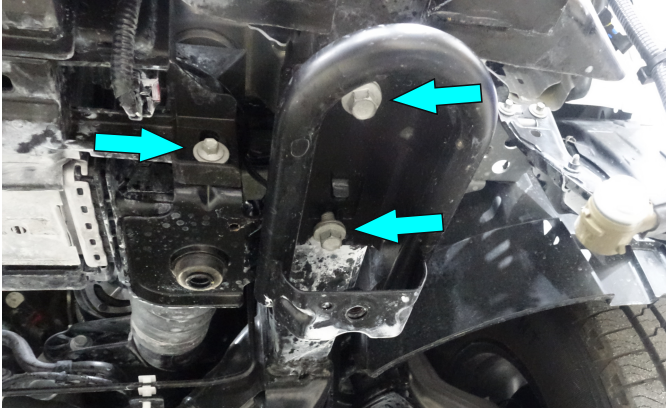

Fig.25

25. Remove factory recovery point from left side of vehicle (fig.25).

***Set aside for re-use later on.**

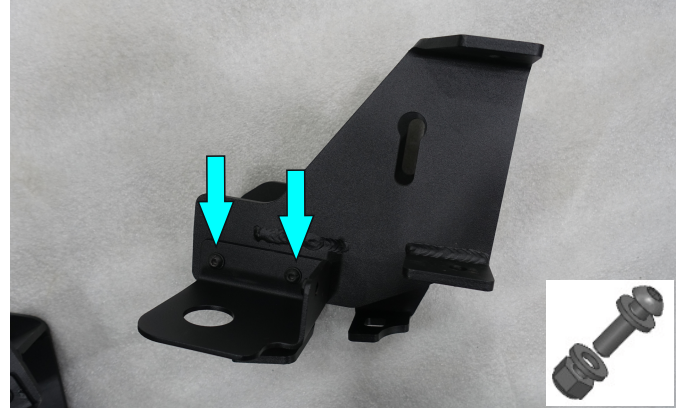

Fig.26

26. Secure left intercooler bracket to left reinforcing bracket (items 15, 24) using screws M6x20, washers M6, nuts M6 (items A2, H1, E2).

***Tighten hardware after that.**

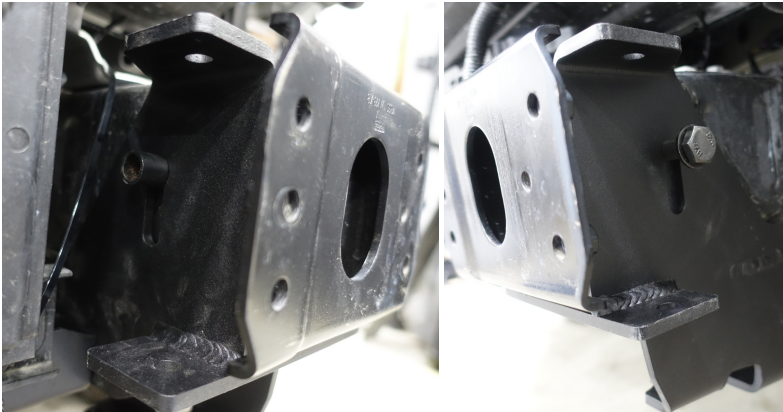

Fig.27

27. Secure reinforcing bracket (item 15) on the left side of the frame using bolt M12x110, washers M12, spacer and nut M12 (items B4, H4, S, E5) (fig.27).

***Spacer should be installed from inner side of the frame.**

***Do not tighten yet.**

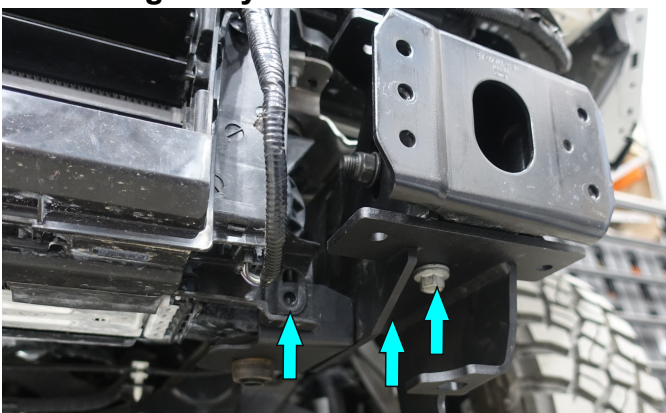
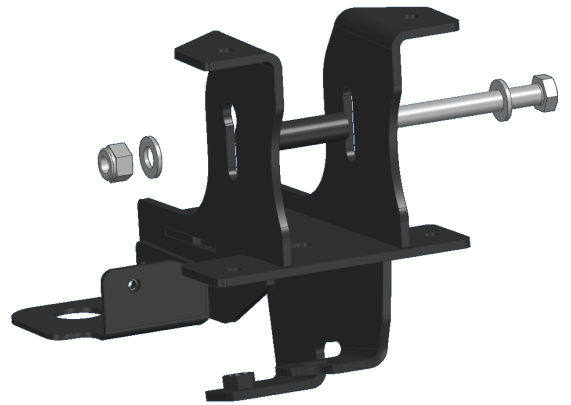

Fig.28

28. Secure left reinforcing bracket (item 15) using factory bolts (fig.28).

***Do not tighten yet.**

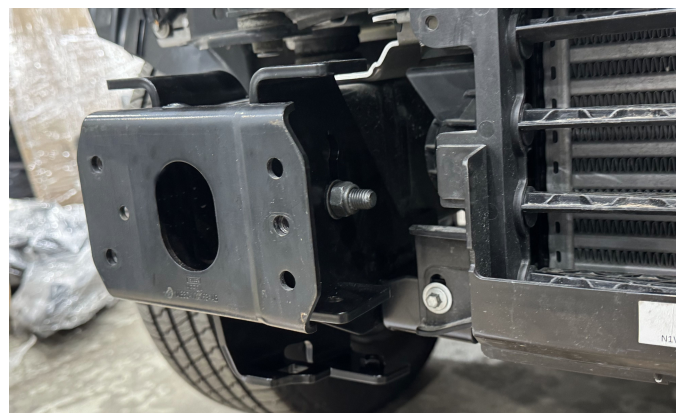

Fig.29

29. Repeat steps 25-28 for right side of vehicle.

INSTALLATION PROCEDURE

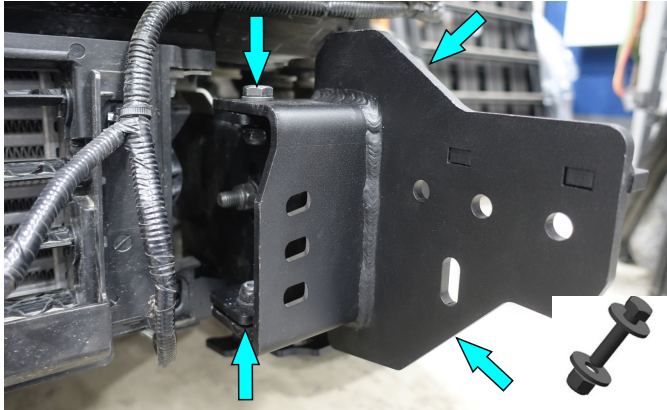

Fig.30

30. Secure frame brackets (items 16, 18) using bolts M10x30, washers M10, nuts M10 (items B2, H3, E4).

***Do not tighten yet.**

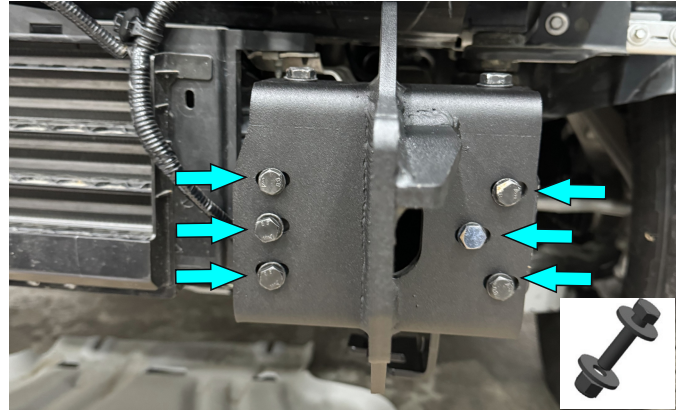

Fig.31

31. Secure frame brackets using factory bolts (from step 14) and bolts M8x30, washers M8, nuts M8 (items B1, H2, E3).

***Do not tighten yet.**

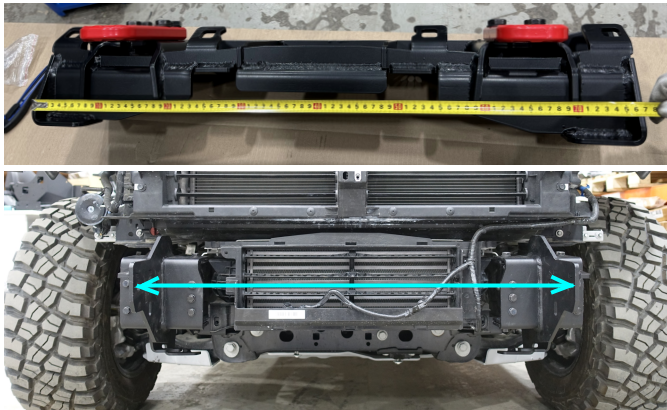

Fig.32

32. Measure the length of winch bracket (item 13). Set up the brackets according to (measured distance + 2 mm) (fig.32).

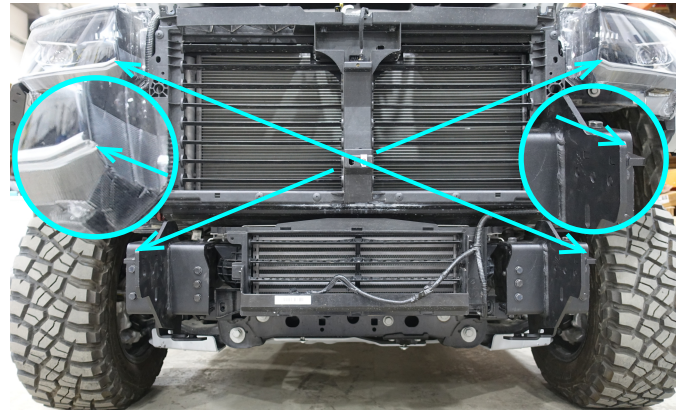

Fig.33

33. Make sure that the distance from the headlights to the opposite corners of frame brackets are the same (fig.33).

***Tighten hardware after that.**

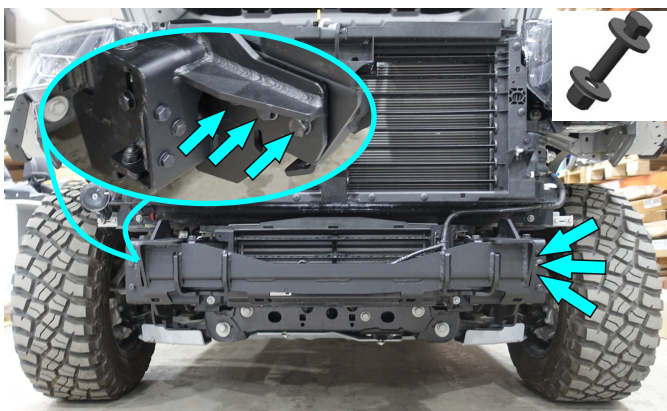

Fig.34

34. Secure winch bracket (item 13) using bolts M12x50, washers M12, nuts M12 (items B3, H4, E5) as shown in fig. 34.

***Tighten hardware after that.**

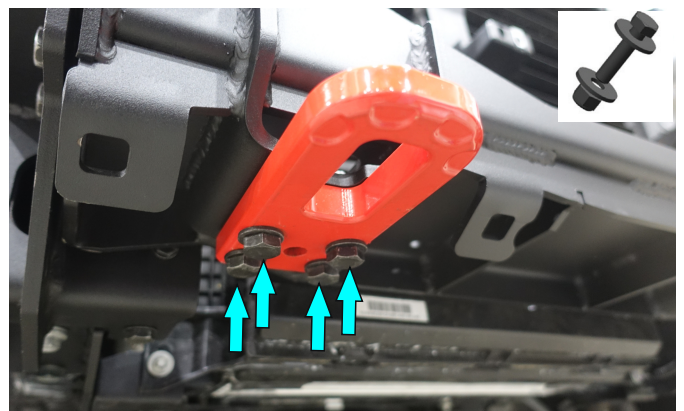

Fig.35

35. Install recovery points (item 29) to the winch bracket using bolts M12x50, washers M12, nuts M12 (items B3, H4, E5).

***Tighten hardware after that.**

INSTALLATION PROCEDURE

Grille installation procedure

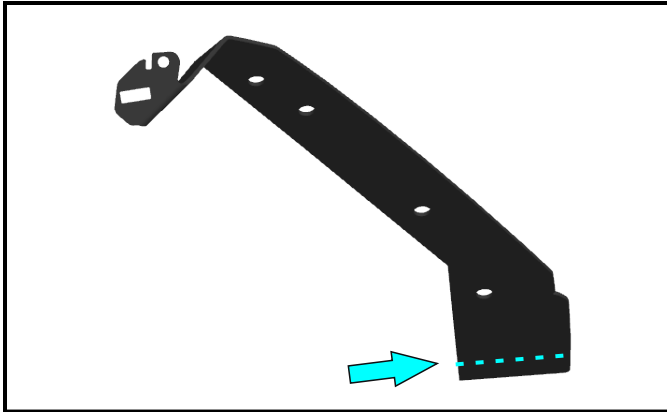

Fig.36

36. If your vehicle has EGR fender flares, cut grille brackets (items 1, 5) following marked line (fig. 36). Cover all trimming points using corrosion resistance coating.



Fig.37

37. Secure grille brackets (item 1, 5) to side parts of grille using factory hardware (fig.37).
***Tighten hardware after that.**

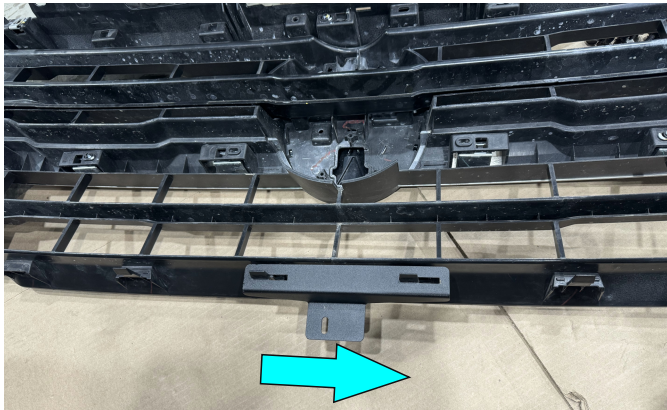

Fig.38

38. Install and slide central grille bracket (item 33) (fig.38).



Fig.39

39. Install grille (fig.39).

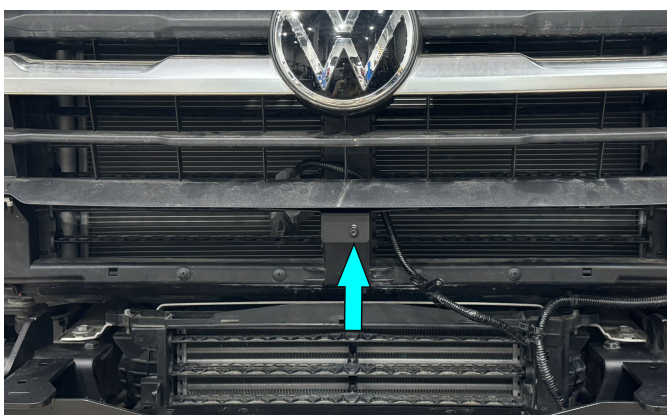

Fig.40

40. Secure central grille bracket (item 33) using bolt M6x20, washer M6 (items A2, H1) (fig.40).
***Tighten hardware after that.**

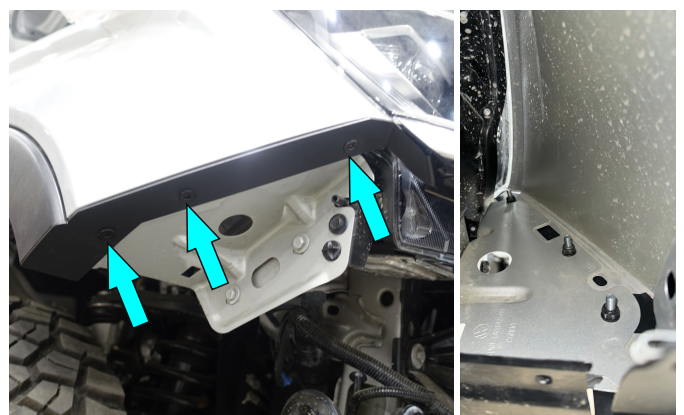

Fig.41

41. Secure grille brackets using screws M6x20, washers M6, nuts M6 (items D, H1, E2).
***Tighten hardware after that.**

INSTALLATION PROCEDURE

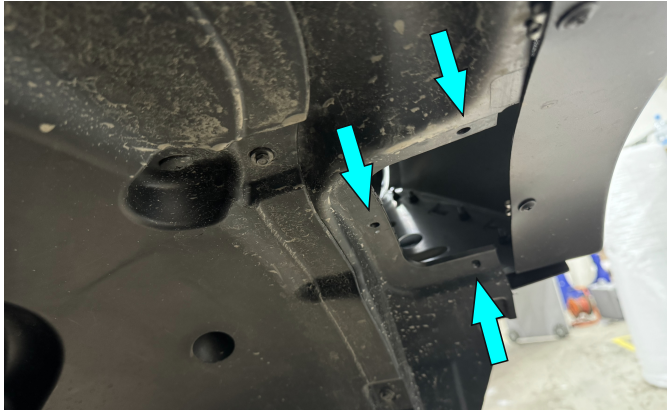

Fig.42

42. Secure factory hatches using factory fittings (fig.42).

Winch installation procedure

* If you are planning to install winch later, save winch control box and fairlead brackets (items 27, 31, 32).

* If your winch has a control box mounted on top, remove it before installation.

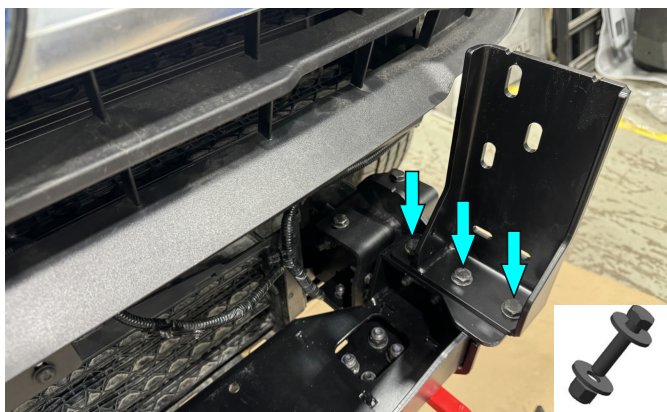

Fig.43

43. Secure bumper brackets (items 19, 26) using bolts M10x30, washers M10, nuts M10 (items B2, H3, E4) (fig.43).

***Do not tighten yet.**

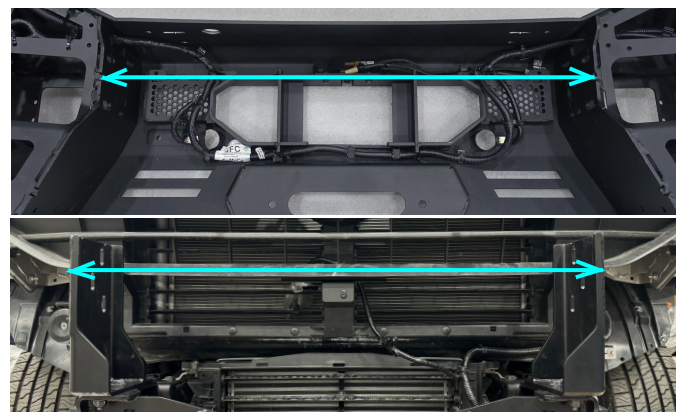

Fig.44

44. Measure the distance of bumper body (item 12). Set up the brackets according to the (measured distance - 2 mm) (fig.44).

INSTALLATION PROCEDURE



Fig.45

45. Make sure that the distance from the headlights to the opposite corners of bumper brackets are the same (fig.45).
***Tighten hardware after that.**



Fig.46

46. Put the winch on winch bracket. Insert fairlead brackets (items 31, 32) between winch and winch bracket. Fix winch using bolts and nuts that are included with the winch.
***Do not tighten yet.**



Fig.47

47. Install winch control box to bracket (item 27) using bolts that are included with the winch.
***Do not tighten yet.**



Fig.48

48. Secure winch control box bracket to winch bracket using bolts M8x30, washers M8, nuts M8 (items B1, H2, E3).
***Do not tighten yet.**

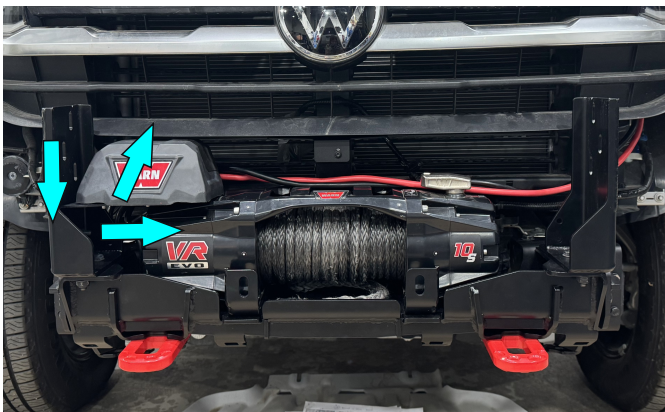

Fig.49

49. Slide control box with bracket 1) down, 2) to the center and 3) to the vehicle as far as possible.
***Tighten hardware from step 47-48.**

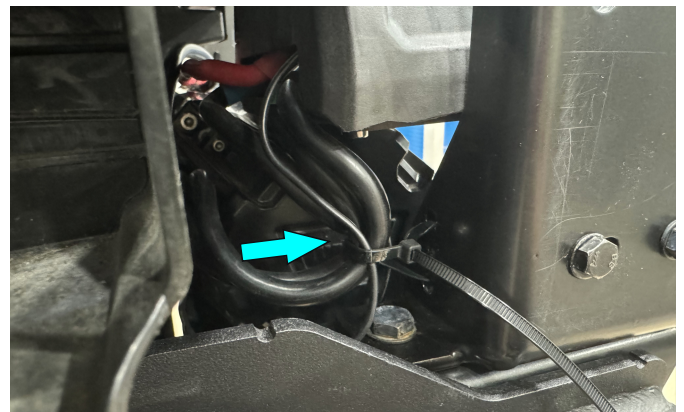

Fig.50

50. Secure factory wiring using cable ties (item U). Connect the winch (fig.50).

INSTALLATION PROCEDURE

Bumper body installation procedure



Fig.51

51. Fix end caps (items 7, 8) to the bumper body (item 12) using bolts M8x30, washers M8, nuts M8 (items B1, H2, E3) (fig.51).

***Tighten hardware after that.**

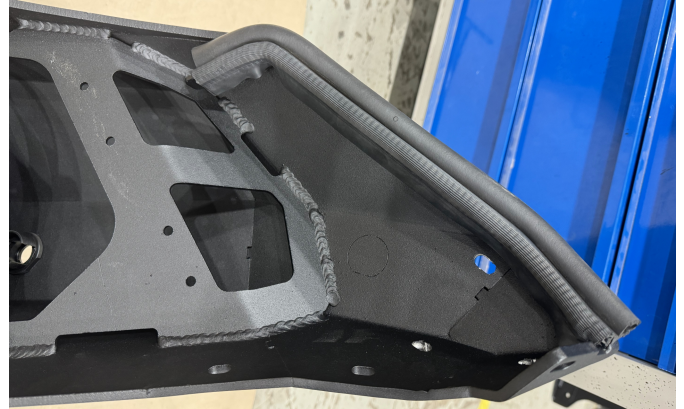

Fig.52

52. Mount weatherstrips (item 9) on bumper body (fig.52).

Steps 53-54 in case you have EGR fender flares and Rival kit 2D.0083.1

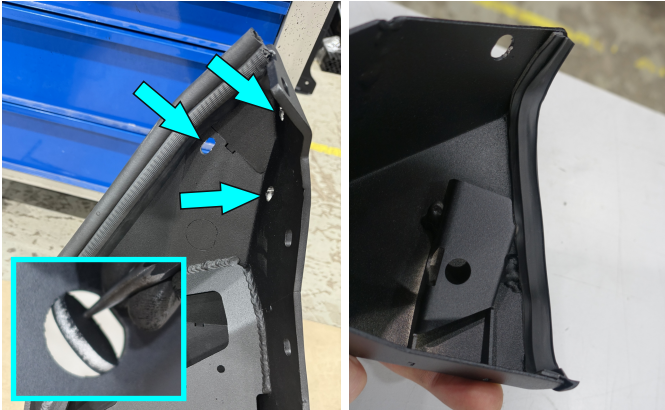

Fig.53

Fig.54

53. Hammer out 3 plugs on each side (fig. 53). Stick the weatherstrip to fender flares (fig. 54).

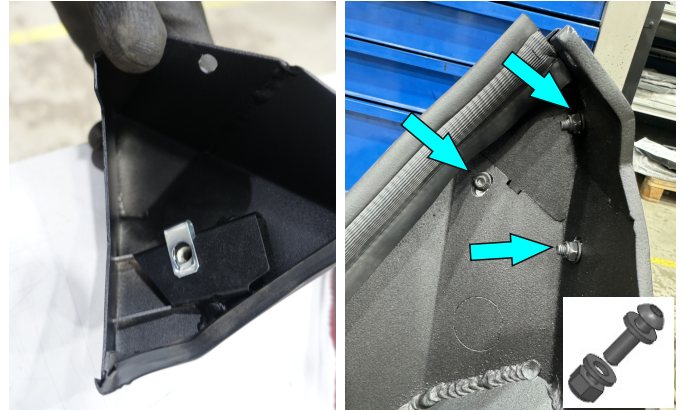

Fig.55

Fig.56

54. Install cage nuts M6 (fig.55) and secure fender flares to bumper body using screws M6x20, washers M6, nuts M6 (fig.56).

***Tighten hardware after that.**

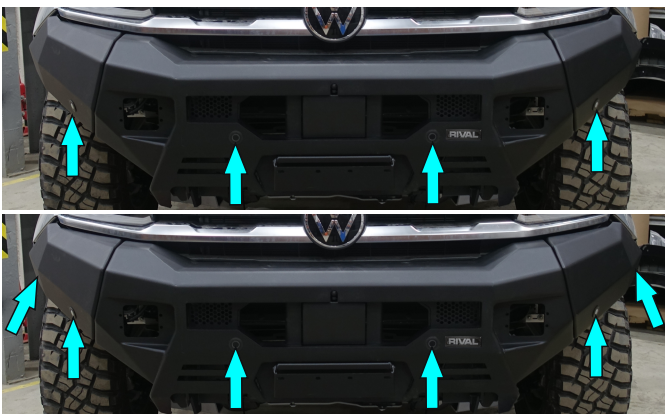

Fig.57

55. If your vehicle has 4 parking sensors, hammer out 4 plugs. If your vehicle has 6 parking sensors, hammer out 6 plugs.

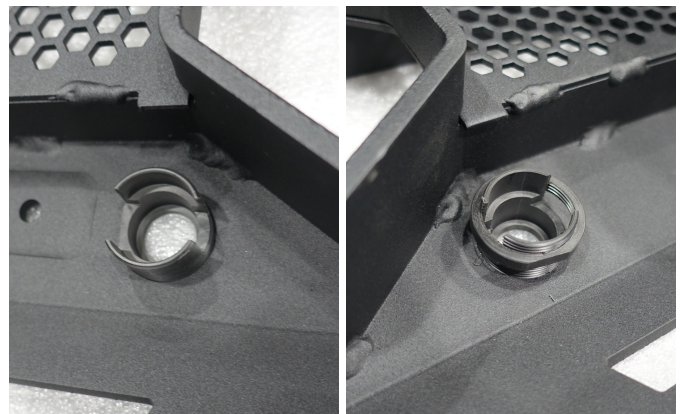

Fig.58

56. Install parking sensor holders (item O), secure them using nuts (item Q). Use wrench (item 6) to tighten hardware.

INSTALLATION PROCEDURE

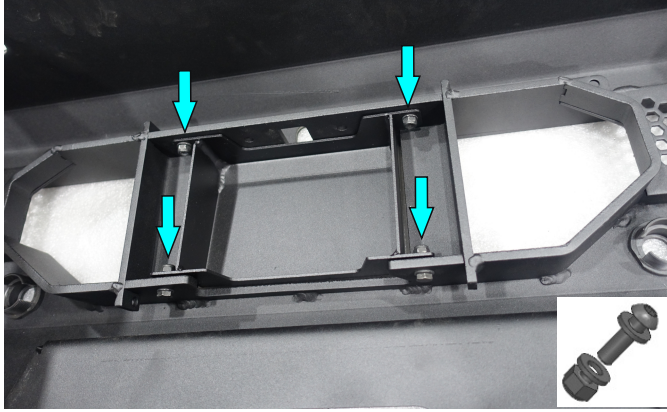

Fig.59

57. If your vehicle is not fitted with radar, secure radar cap (item 35) using screws M6x20, washers M6, nuts M6 (items A2, H1, E2) and skip steps 60-63, 75-77.

***Tighten hardware after that.**

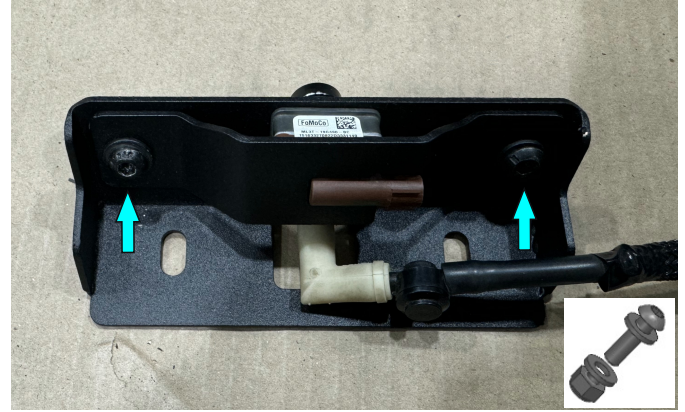

Fig.60

58. If your vehicle is fitted with front camera, install it to camera bracket (item 23) and secure it using camera clamp, screws M6x16, washers M6, nuts M6 (items 22, A1, H1, E2) (fig.60). ***Tighten hardware after that.**

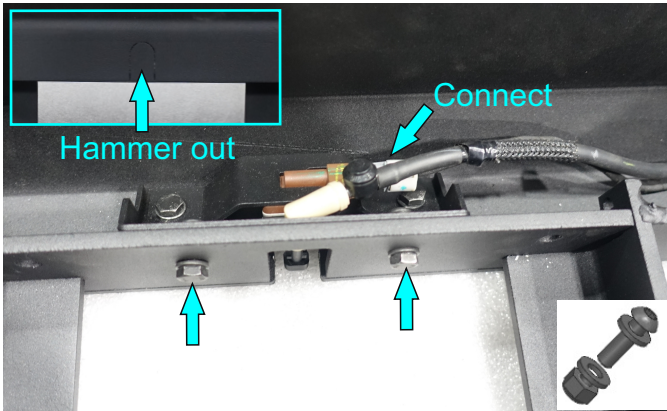

Fig.61

59. Hammer out bumper plug and secure camera using screws M6x20, washers M6, nuts M6 (items A2, H1, E2). Center camera and slide to bumper as far as possible. Tighten hardware, connect the factory wiring plug.

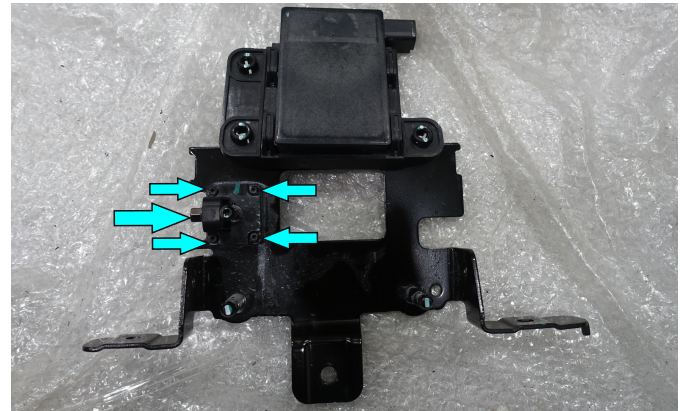

Fig.62

60. Remove radar from factory bracket, and after that the adjusting mechanism (fig.62). ***Set aside for re-use later on.**

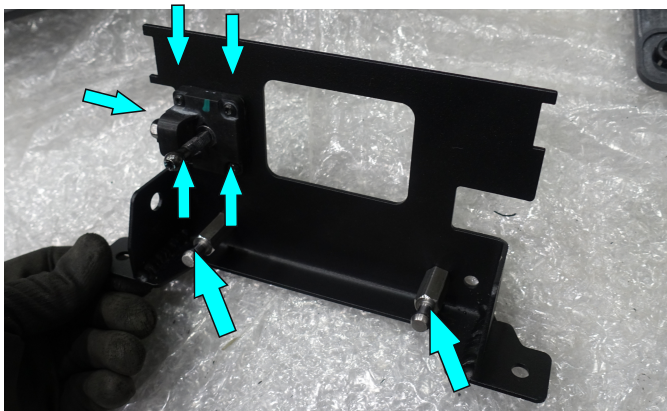

Fig.63

61. Install radar mounting pins (item R) using nuts M6, washers M6 (items E2, H1). Fix adjusting mechanism using nuts M3 (item E1). ***Tighten hardware after that.**

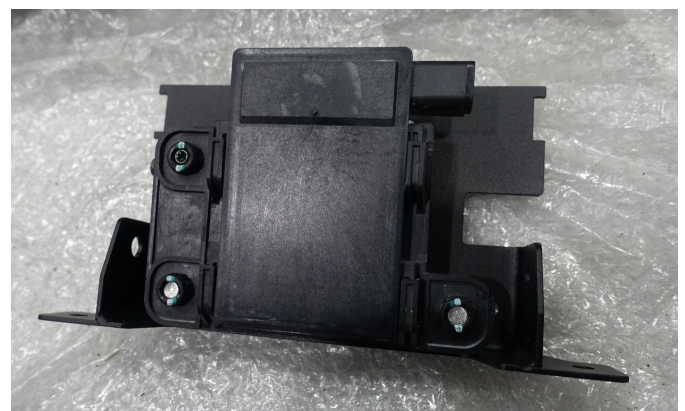

Fig.64

62. Secure radar on radar bracket.

INSTALLATION PROCEDURE

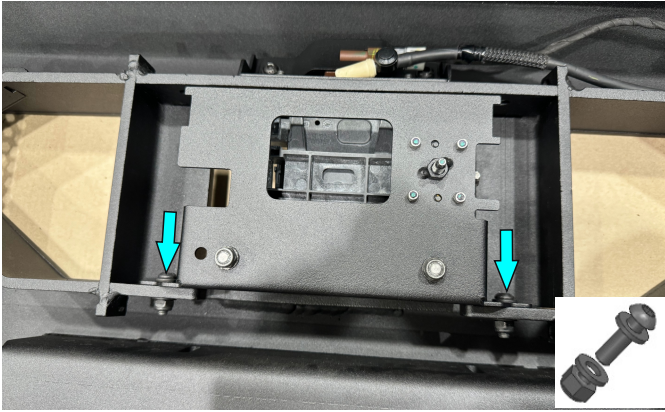

Fig.65

63. Secure radar bracket to bumper body using screws M6x20, washers M6, nuts M6 (items A2, H1, E2).

***Tighten hardware after that.**

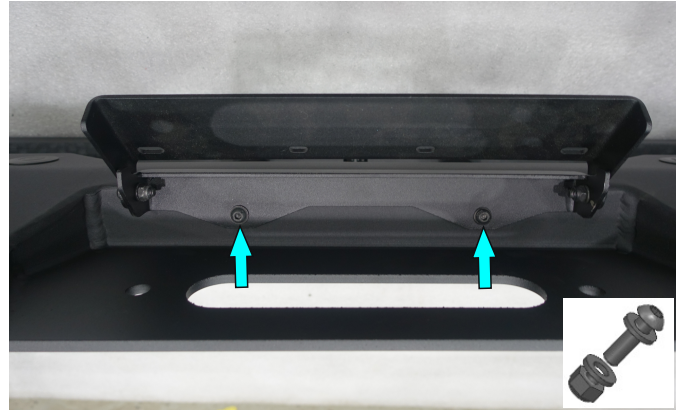

Fig.66

64. Secure license plate bracket (item 30) to bumper body using screws M6x20, washers M6, nuts M6 (items A2, H1, E2).

***Do not tighten yet.**



Fig.67

65. Measure thickness of fairlead and shackle that you are planning to install. Slide license plate bracket according to measured distances. ***Be aware that thickness should be less than 75 mm.**

***Tighten hardware after that.**

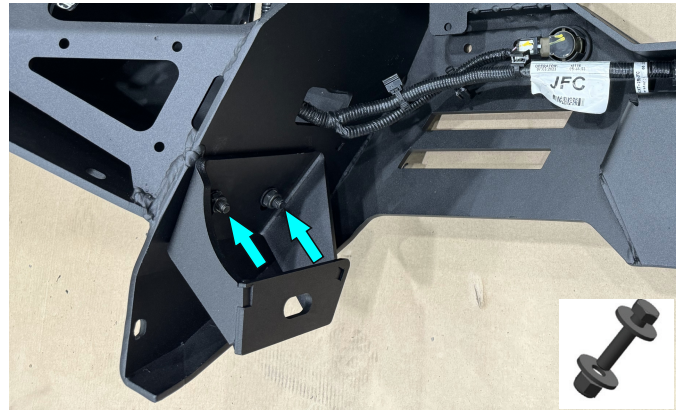

Fig.68

66. Secure adjustment brackets (items 20, 25) to bumper body using bolts M8x30, washers M8, nuts M8 (items B1, H2, E3).

***Do not tighten yet.**

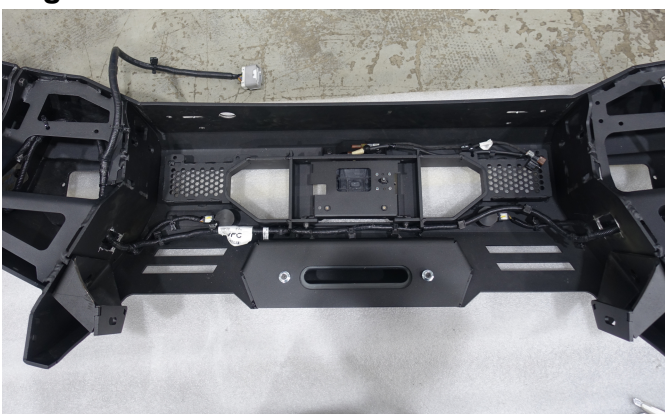

Fig.69

67. Relocate wiring from factory bumper to Rival bumper.



Fig.70

68. Install parking sensors in the holders, secure them using clamps (item P) (fig.70).

INSTALLATION PROCEDURE

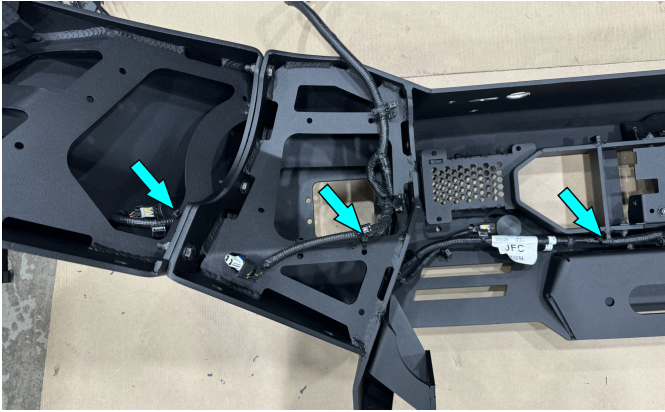

Fig.71

69. Secure the wiring using cable ties (item U).



Fig.72

70. Install the bumper body on winch bracket. Connect the camera wiring plug and camera pipe.

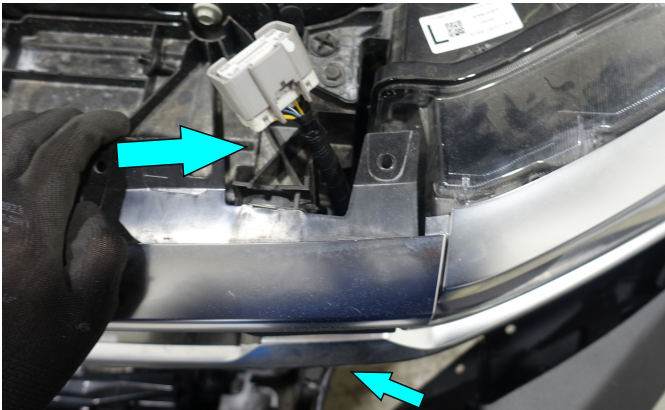

Fig.73

71. Pull the wire connector through the bumper and grille.

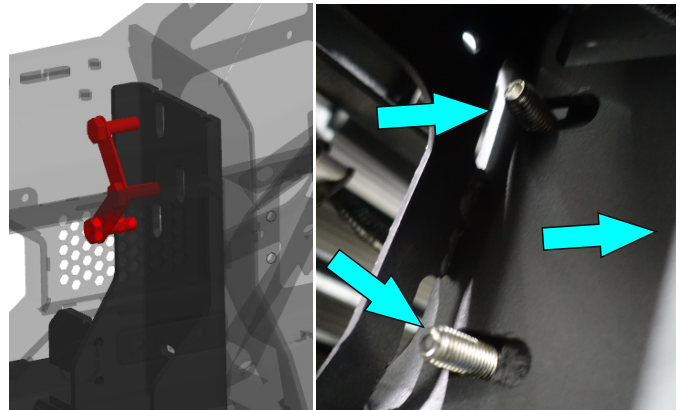

Fig.74

72. Install insert nuts 3xM10 (item L) through central holes of the bumper. Secure it using nuts M10, washers M10 (items E4, H3).
***Do not tighten yet.**

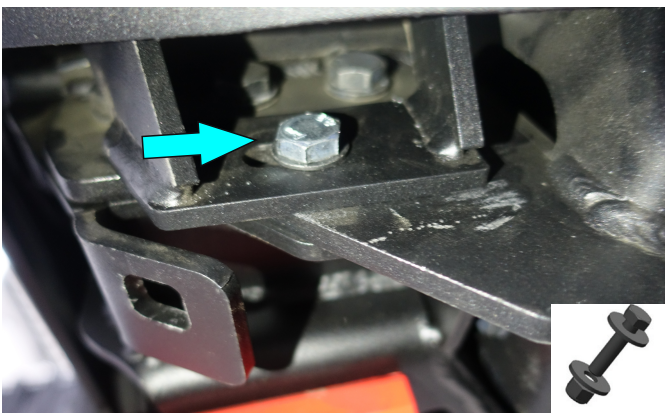

Fig.75

73. Secure brackets from step 65 to winch bracket using bolts M12x50, washers M12, nuts M12 (items B3, H4, E5).
***Do not tighten yet.**



Fig.76

74. Align bumper body on the vehicle and tighten hardware from step 66, 72, 73. Make sure that the distance between factory grille and RIVAL bumper body is not less than 3mm.

INSTALLATION PROCEDURE



Fig.77

75. Align the radar position perpendicular to the road using side bolt on adjusting mechanism.

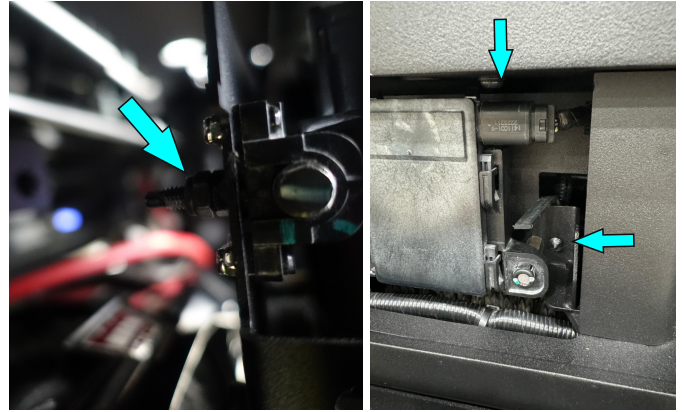

Fig.78

76. Install nut M6 (item E2) on adjusting mechanism. Connect the radar plug and secure the wiring.



Fig.79

77. Install factory radar cover, secure it using factory clips.

Step 78-82 in case you have lightbar



Fig.80

78. Hammer out plugs from the upper face of bumper body (fig. 80).



Fig.81

79. Install lightbar brackets (items 2, 4) to lightbar using lightbar hardware.
***Do not tighten yet.**

INSTALLATION PROCEDURE



Fig.82

80. Install lightbar on the bumper body and secure the brackets (items 2,4) using bolts M8x30, washers M8, nuts M8 (items B1, H2, E3). Adjust the lightbar.

***Tighten hardware after that.**



Fig.84

82. Secure lightbar cap (item 3) to the bumper body using bolts M8x30, washers M8 (item B1, H2). Adjust lightbar cap.

***Tighten hardware after that.**



Fig.86

84. Install factory or any aftermarket radiator skid plate (fig. 86).

***Tighten hardware after that.**

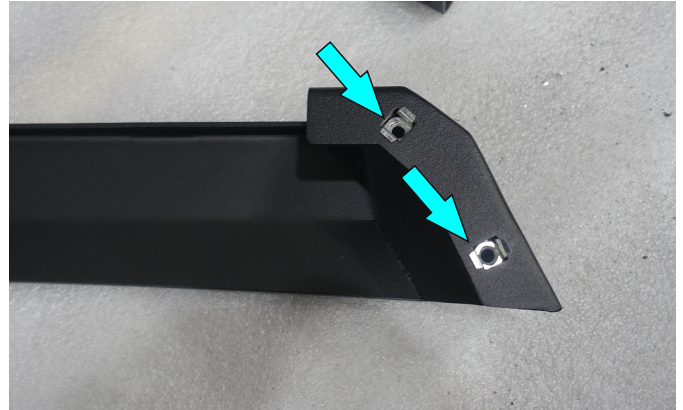

Fig.83

81. Install cage nuts M8 (item F) on lightbar cap (item 3) as shown on fig.83.



Fig.85

83. Install a fairlead to the bumper using fairlead hardware and insert nuts M10 (item M).

***Tighten hardware from steps 46, 83.**



Fig.87

85. Install insert nuts M10 with wires (item K).

INSTALLATION PROCEDURE



Fig.88

86. Install bash plate (item 17) and secure it using screws M10x30, washers M10 (item C, N). Align the bash plate.

***Tighten hardware after that.**

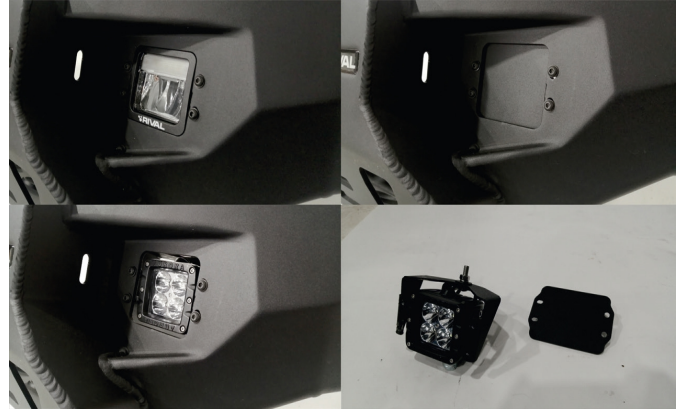

Fig.89

87. **Rival LED lights:** install them using supplied hardware.

Others or light caps (item 34): install them using screws M6x20, washers M6 and LED light brackets (items 28, A2, H1).

***Tighten hardware after that.**

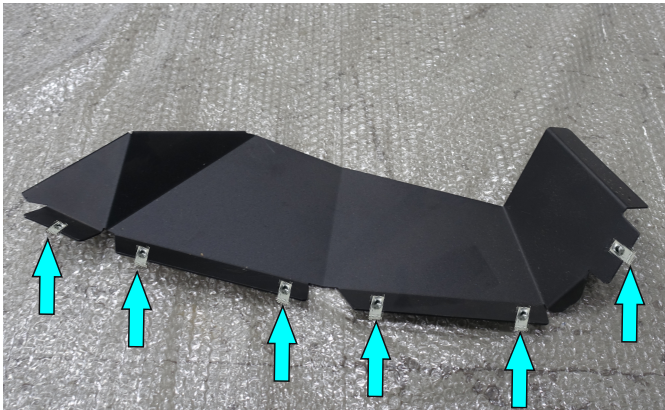

Fig.90

88. Install cage nuts M6 (item G) on flaps (items 11, 14) (fig.90).



Fig.91

89. Install flaps and secure them using screws M6x20, washers M6 (items A2, H1) (fig.91).

***Tighten hardware after that.**



Fig.92

90. Mark a cutting line. Cut plastic fender using jig-saw or shears (fig.92).

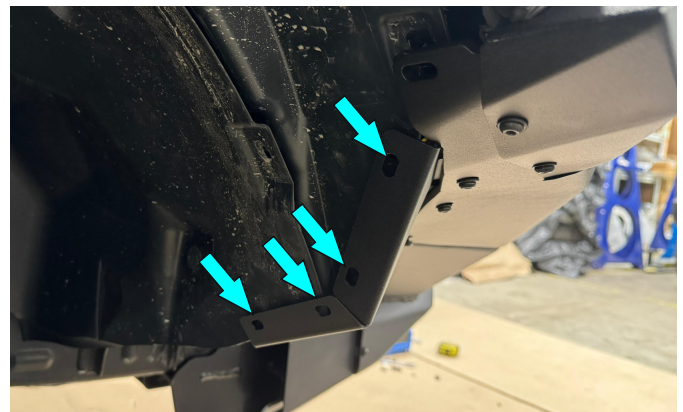

Fig.93

91. Mark and drill holes in plastic fender according with holes in flap on each side of the vehicle.

INSTALLATION PROCEDURE



Fig.94

92. Install u-nuts (item J) on plastic fenders (fig.94).

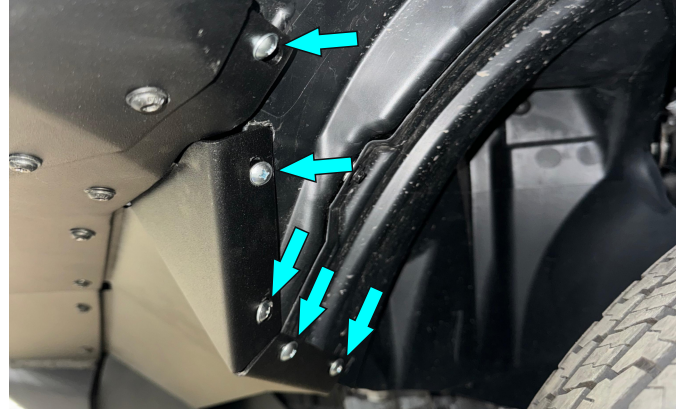

Fig.95

93. Secure flaps using screws (item I) (fig. 95).
***Tighten hardware after that.**

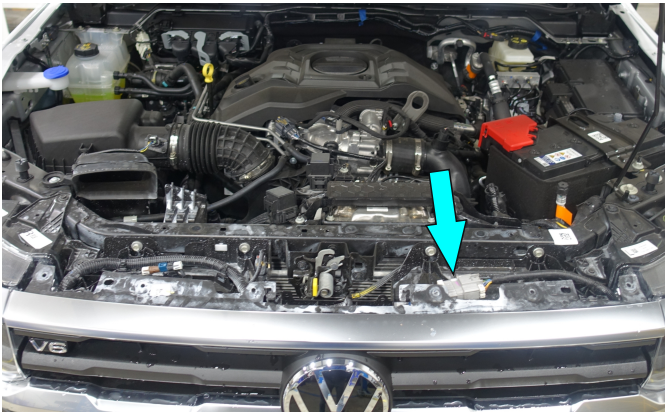

Fig.96

94. Connect factory wiring (fig.96).



Fig.97

95. Install factory bolts (fig.97).
***Tighten hardware after that.**

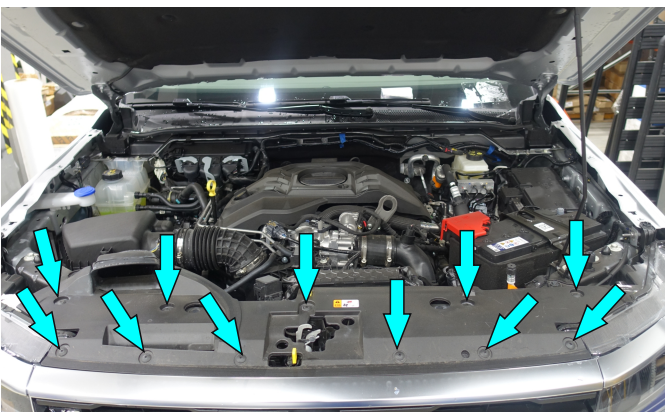

Fig.98

96. Install factory plastic pad clip and secure it using factory clips (fig.98).



Fig.99

97. Connect terminal "-" on the vehicle battery (fig.99).

INSTALLATION PROCEDURE

Before operating a vehicle fitted with RIVAL front bumper:

- make sure all fittings are tightened;
- ensure the integrity of the structure and its components.

