

**2M.0006.1 ; 2M.0006.2 ; 2M.0006.3 ;
2M.0006.4 ; 2M.0006.5**





Regular fasteners



Regular fasteners



Screw a several turns



Loosen bolts



Movement Arrow



Location/Position Arrow



Screw Arrow

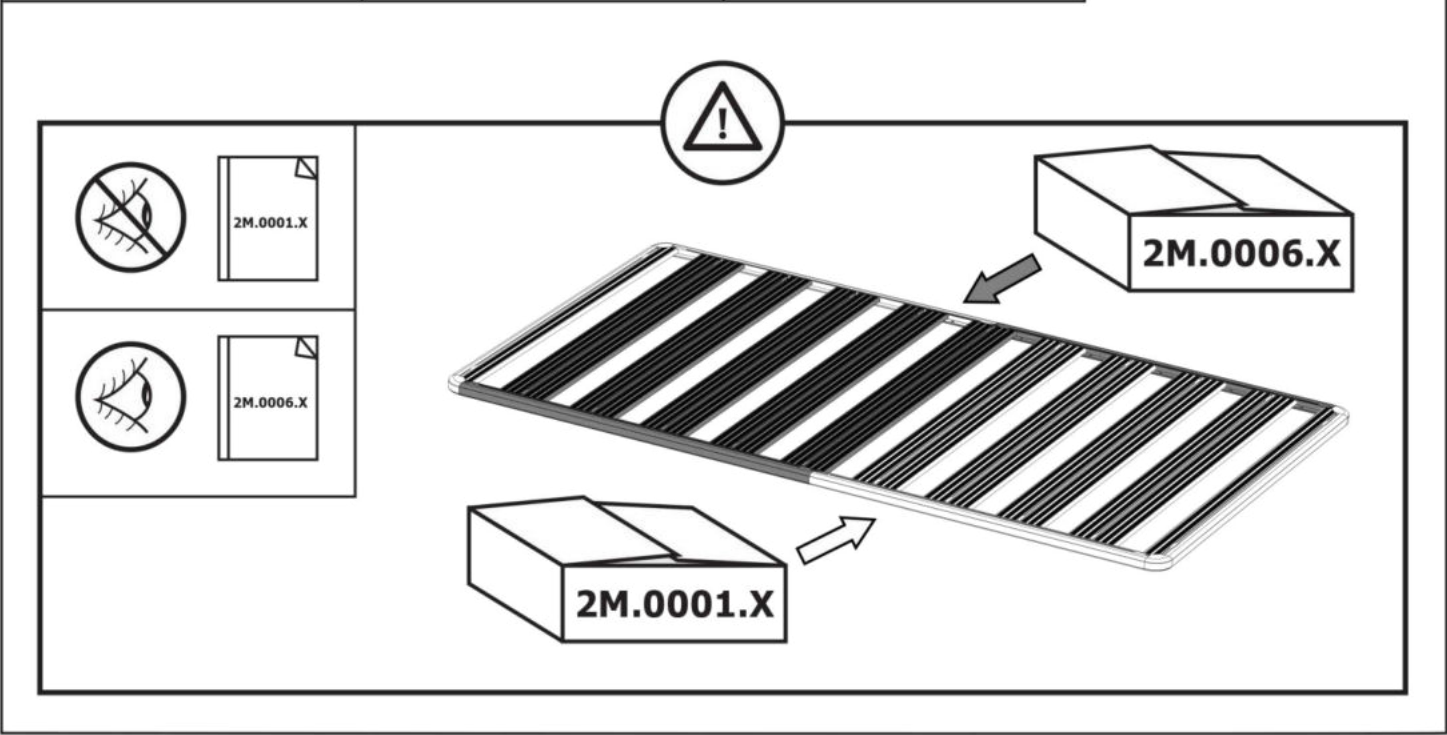
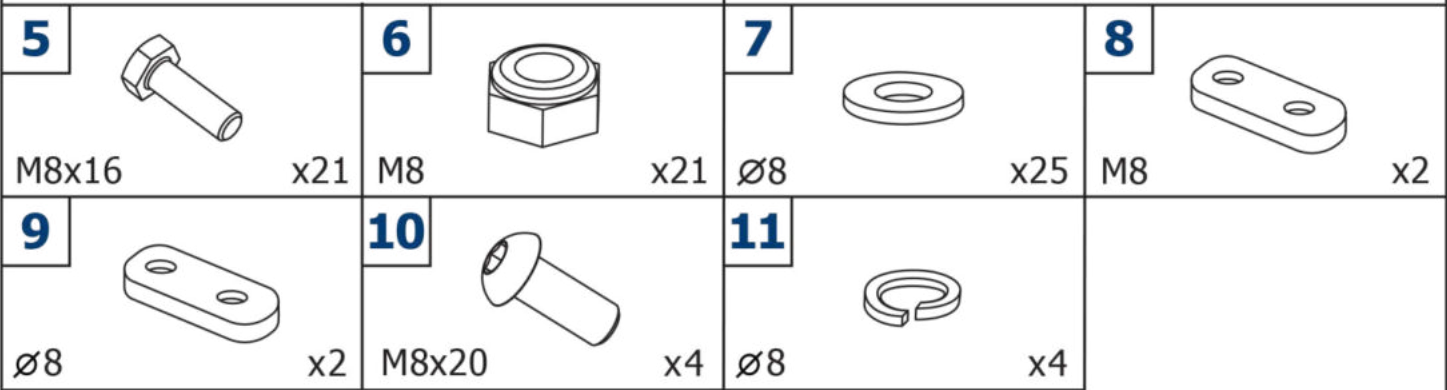
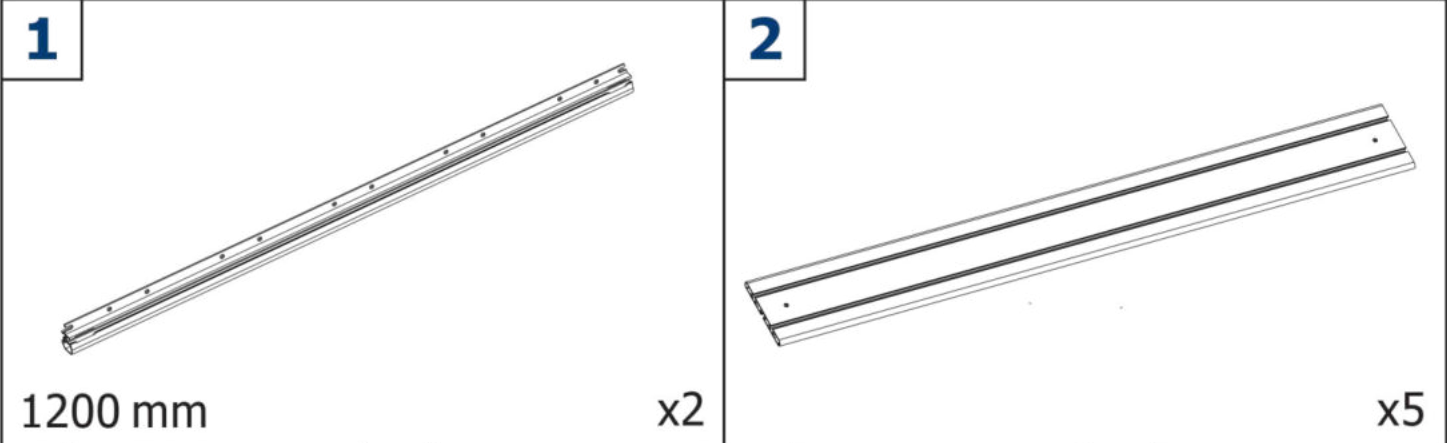

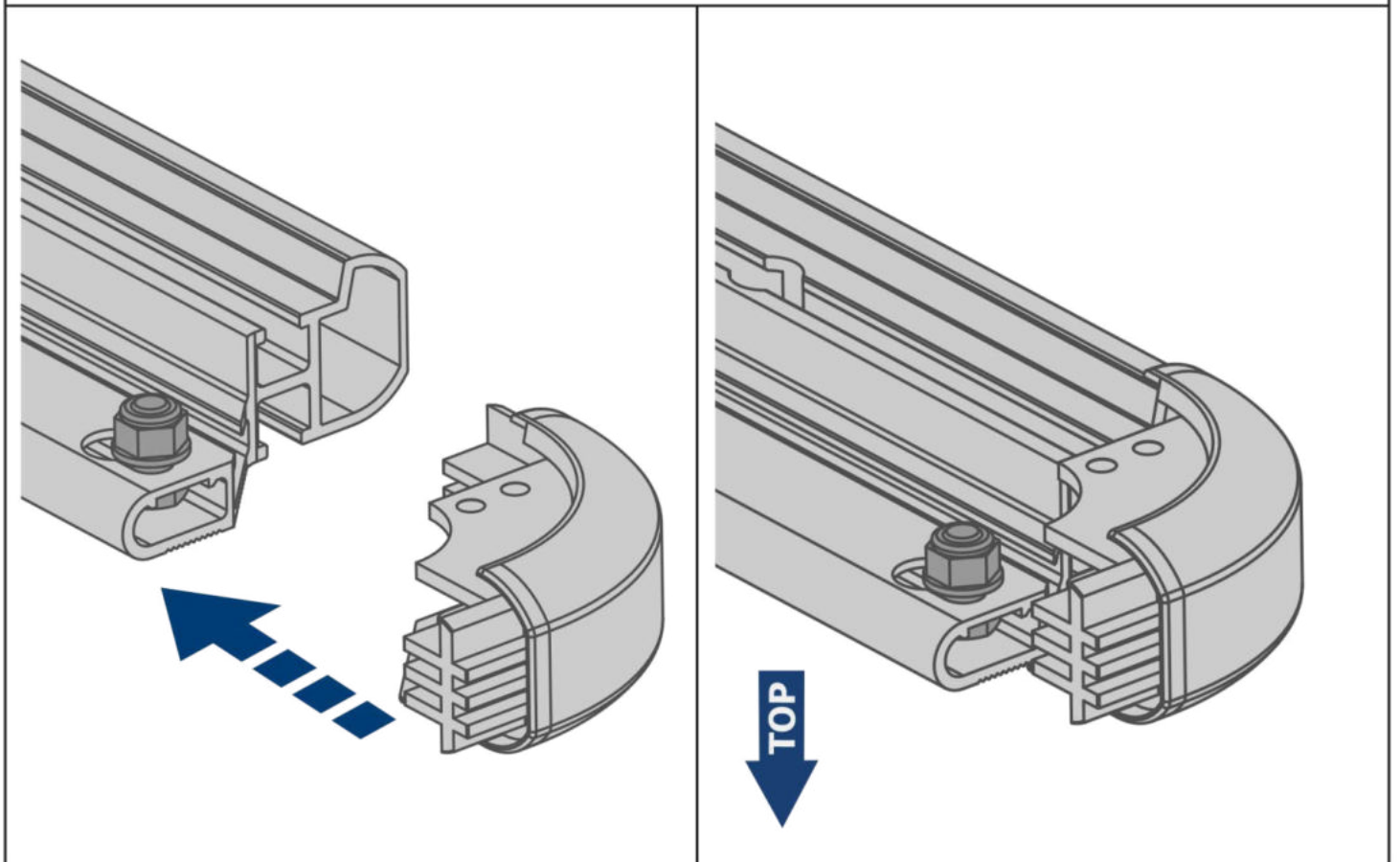
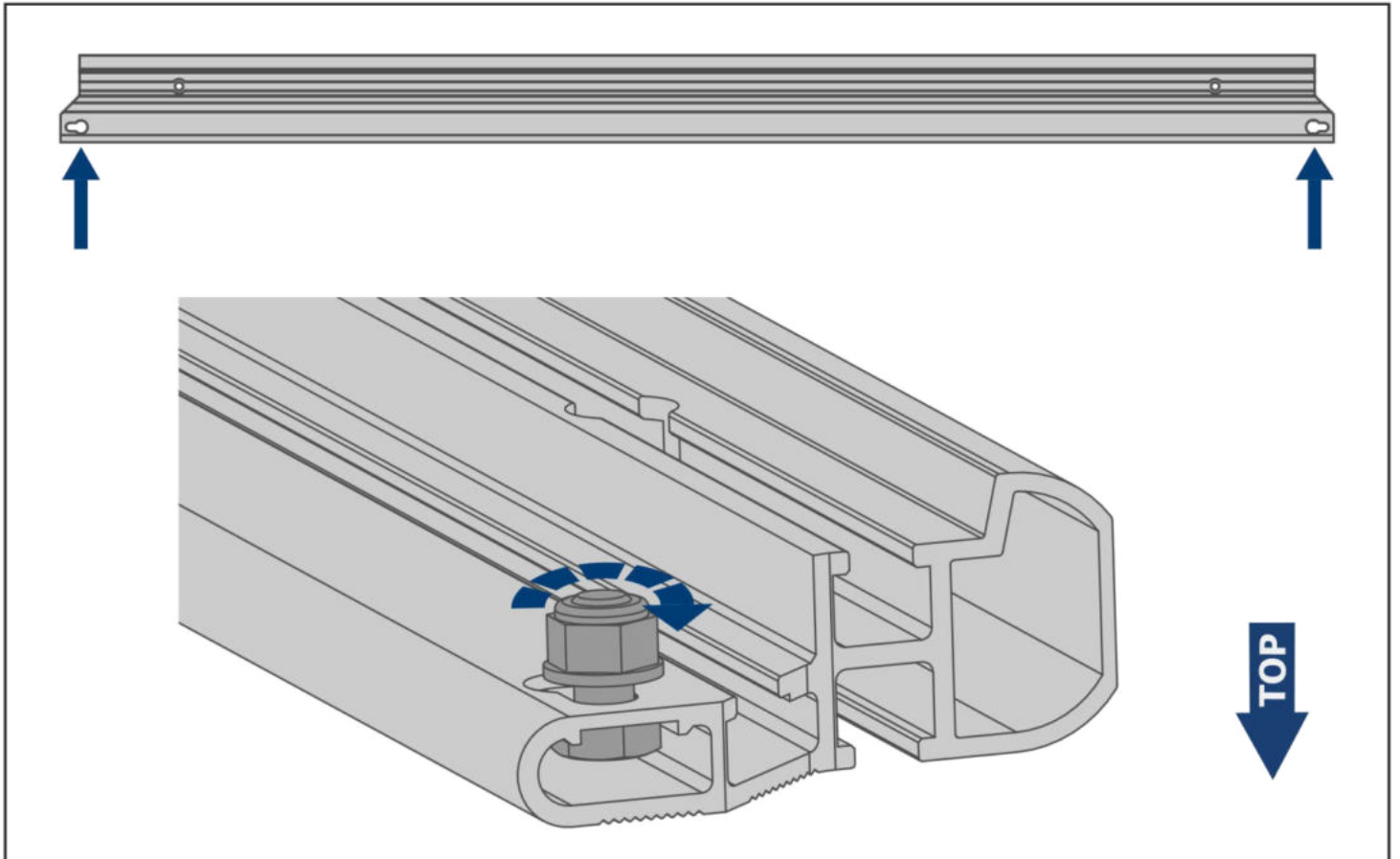

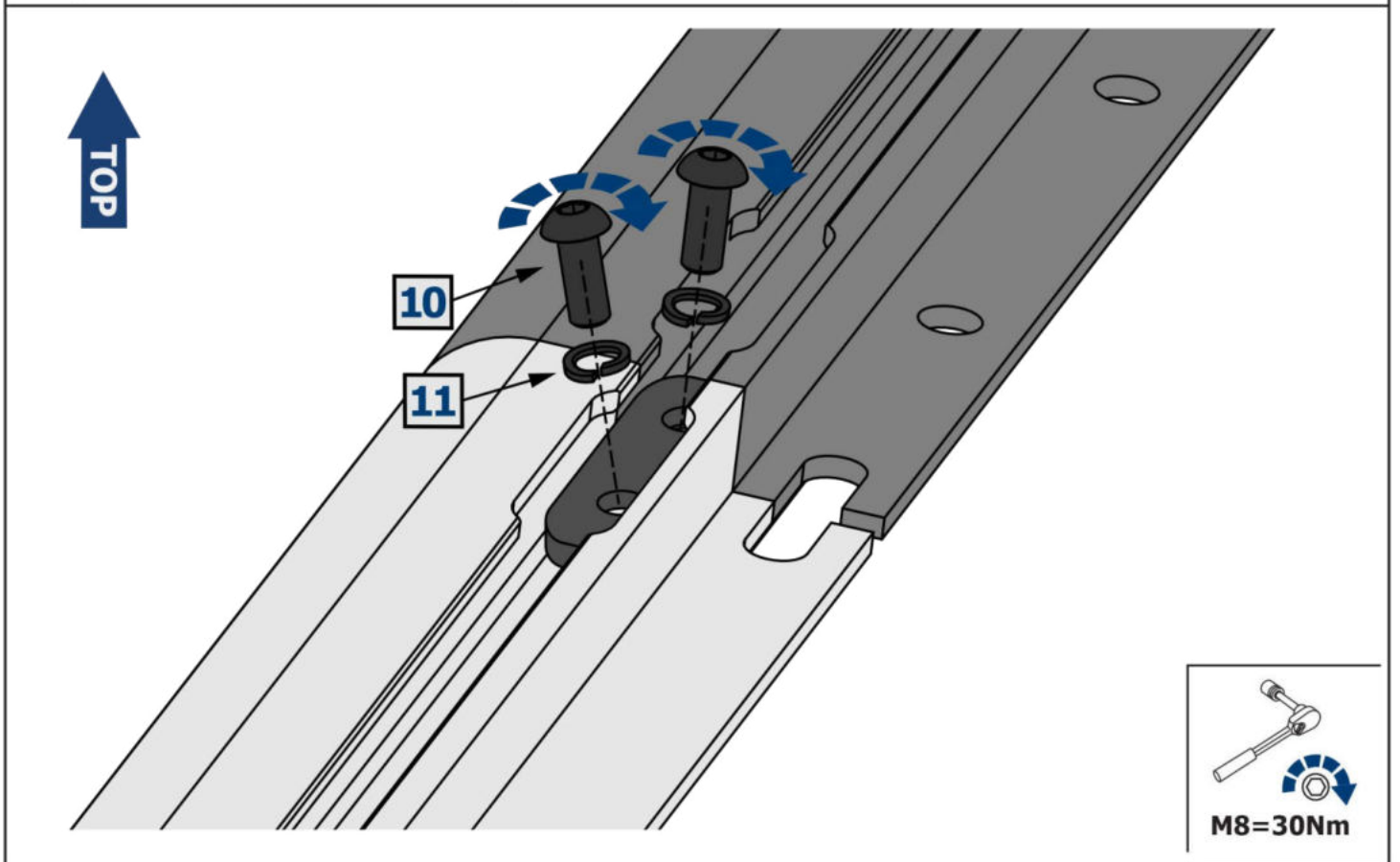
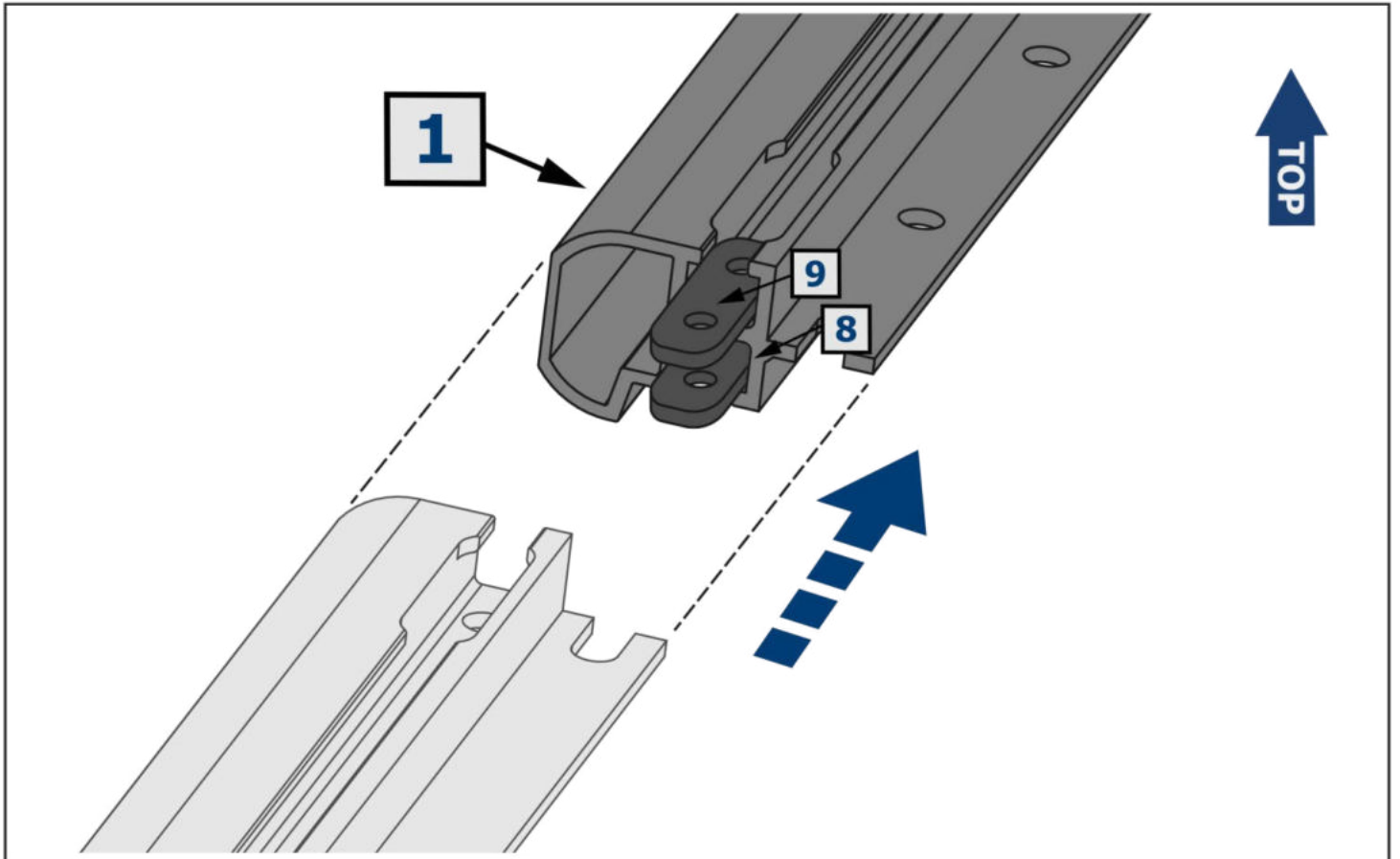

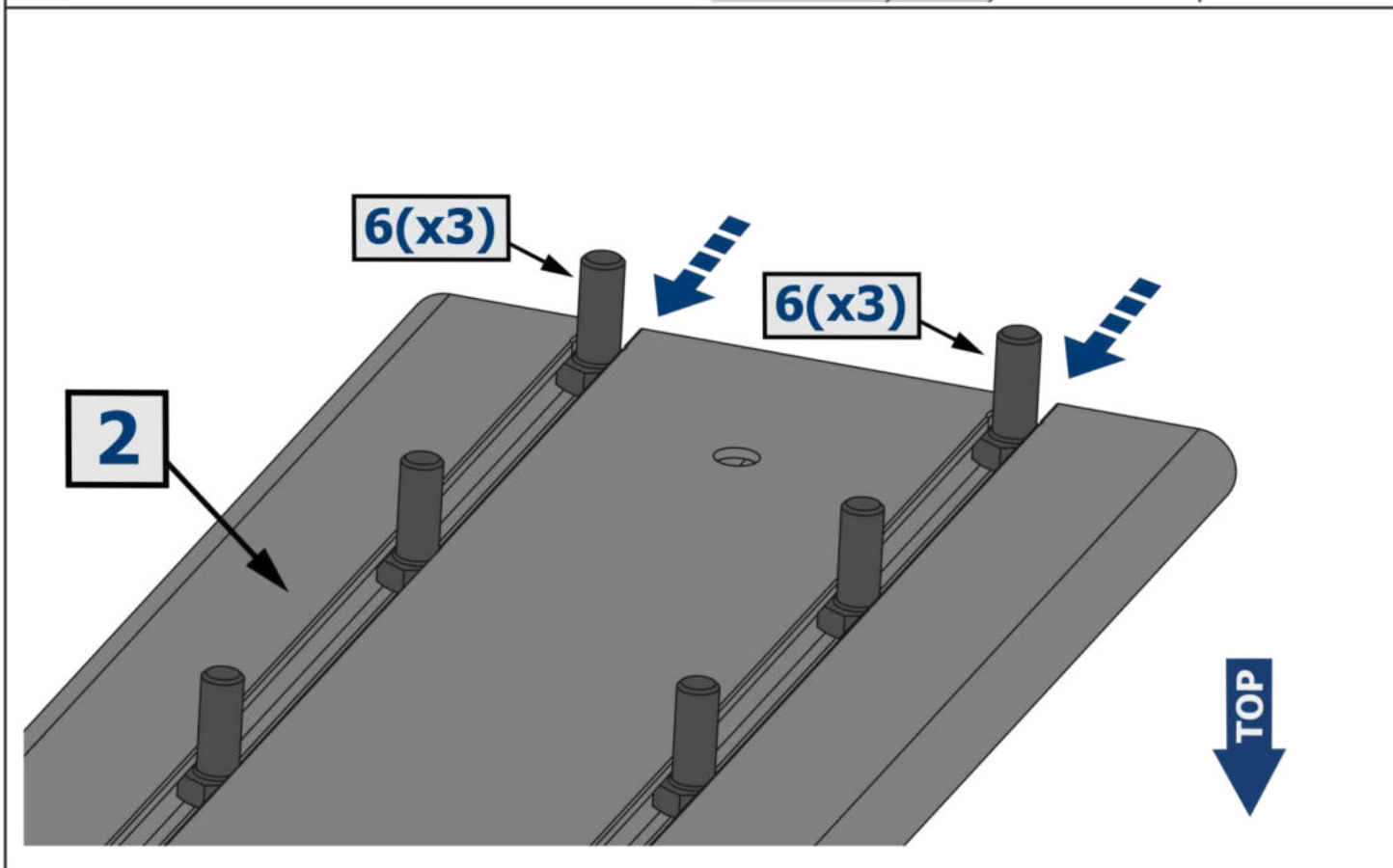
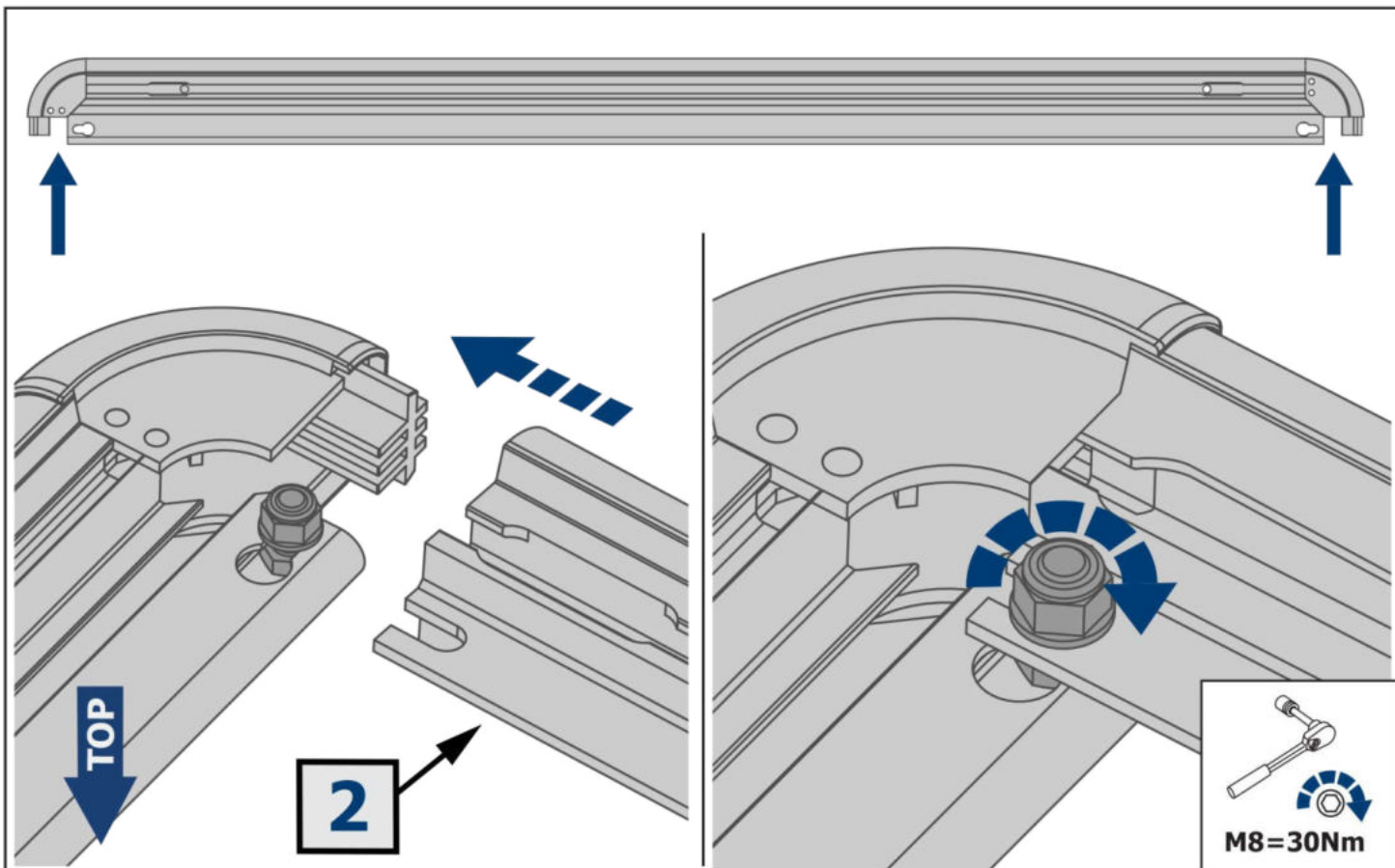

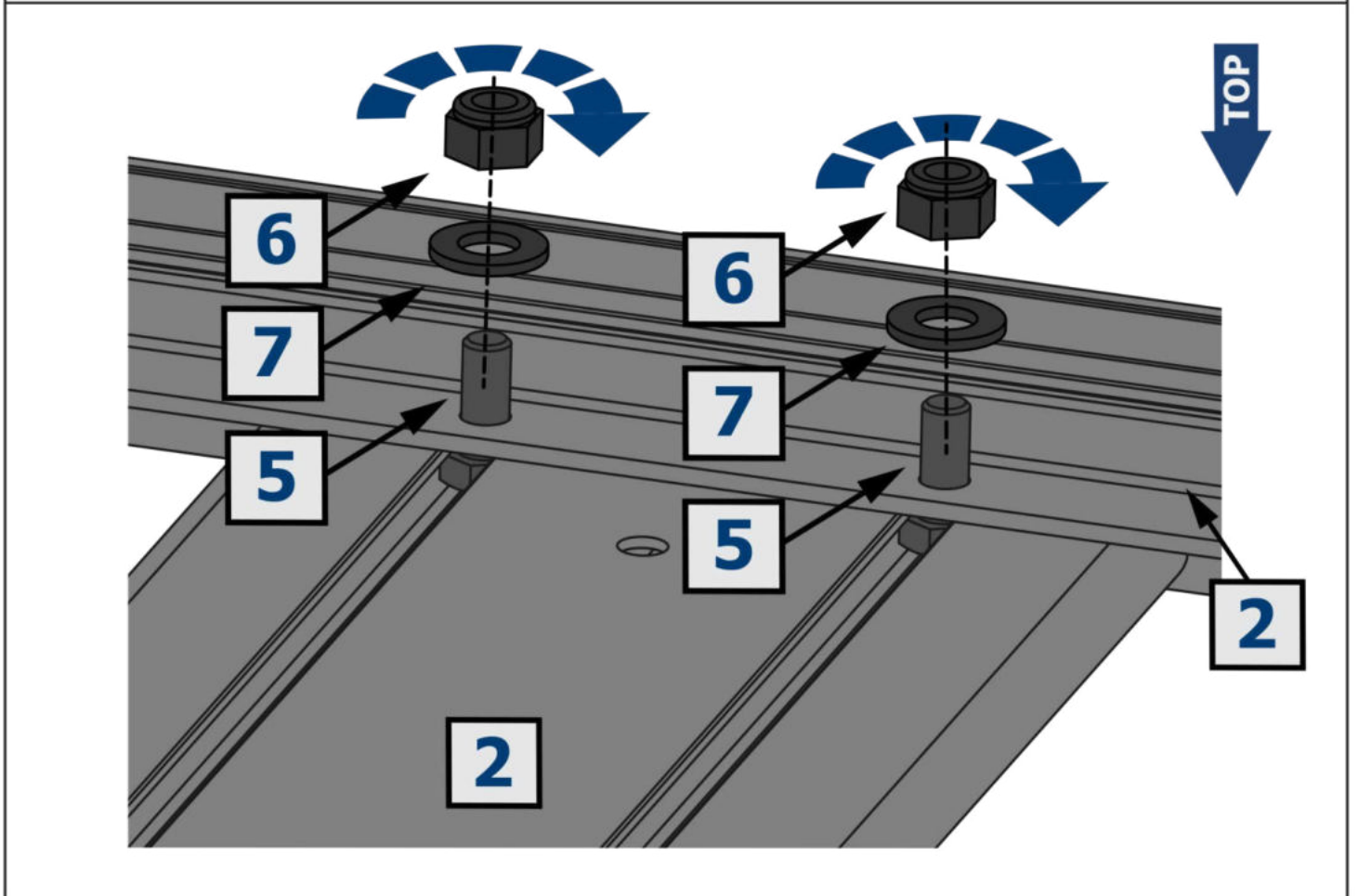
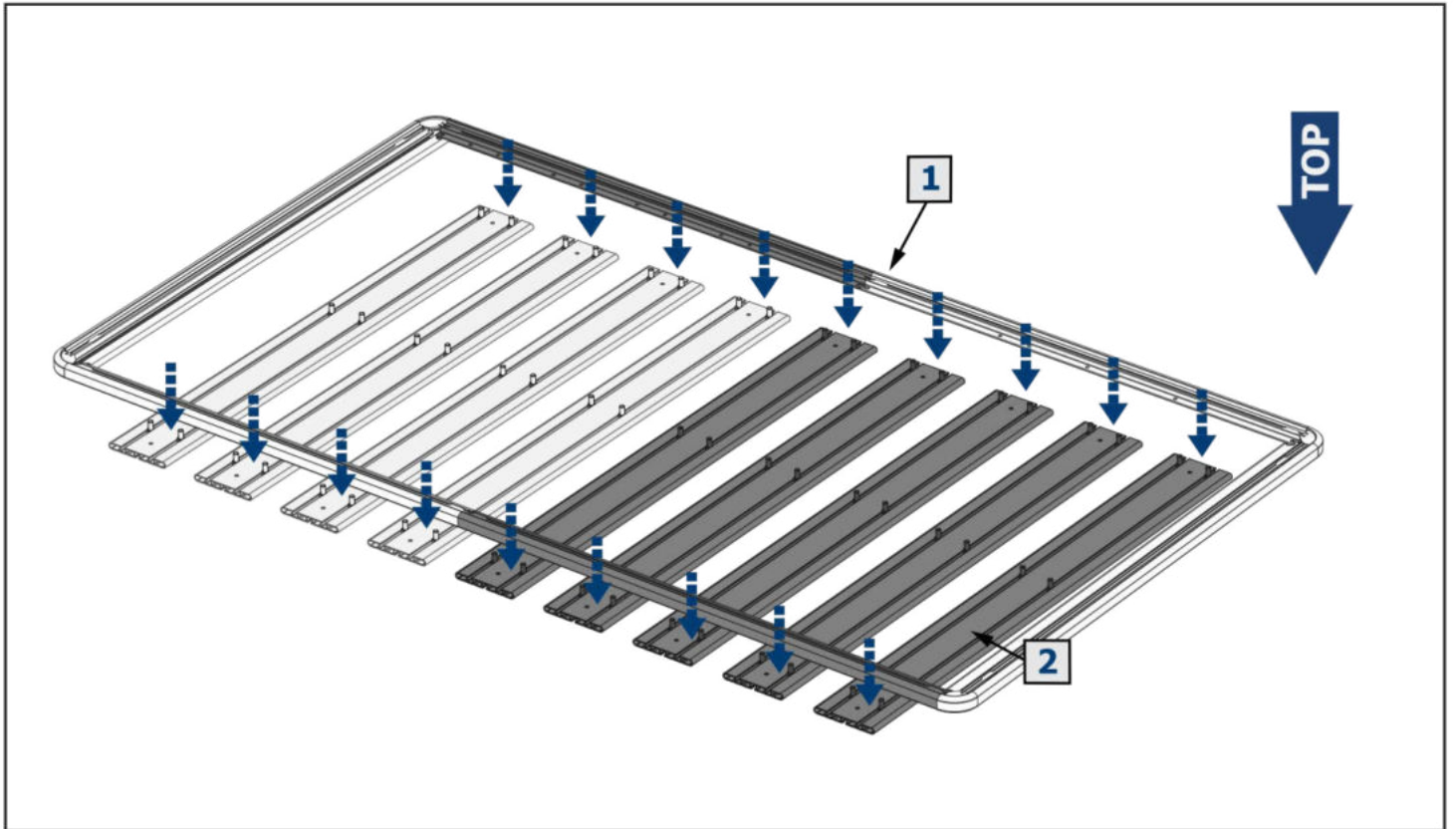

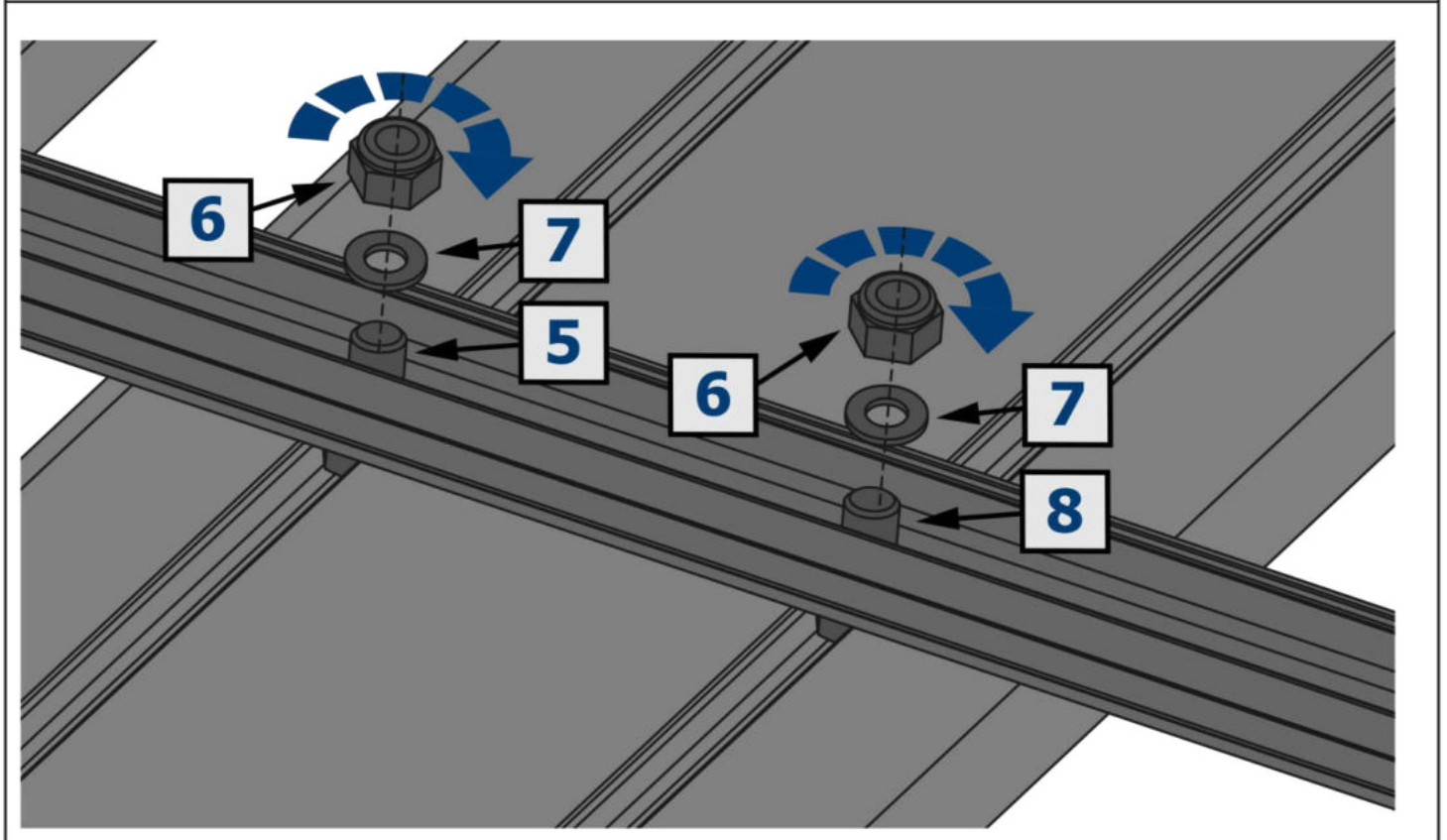
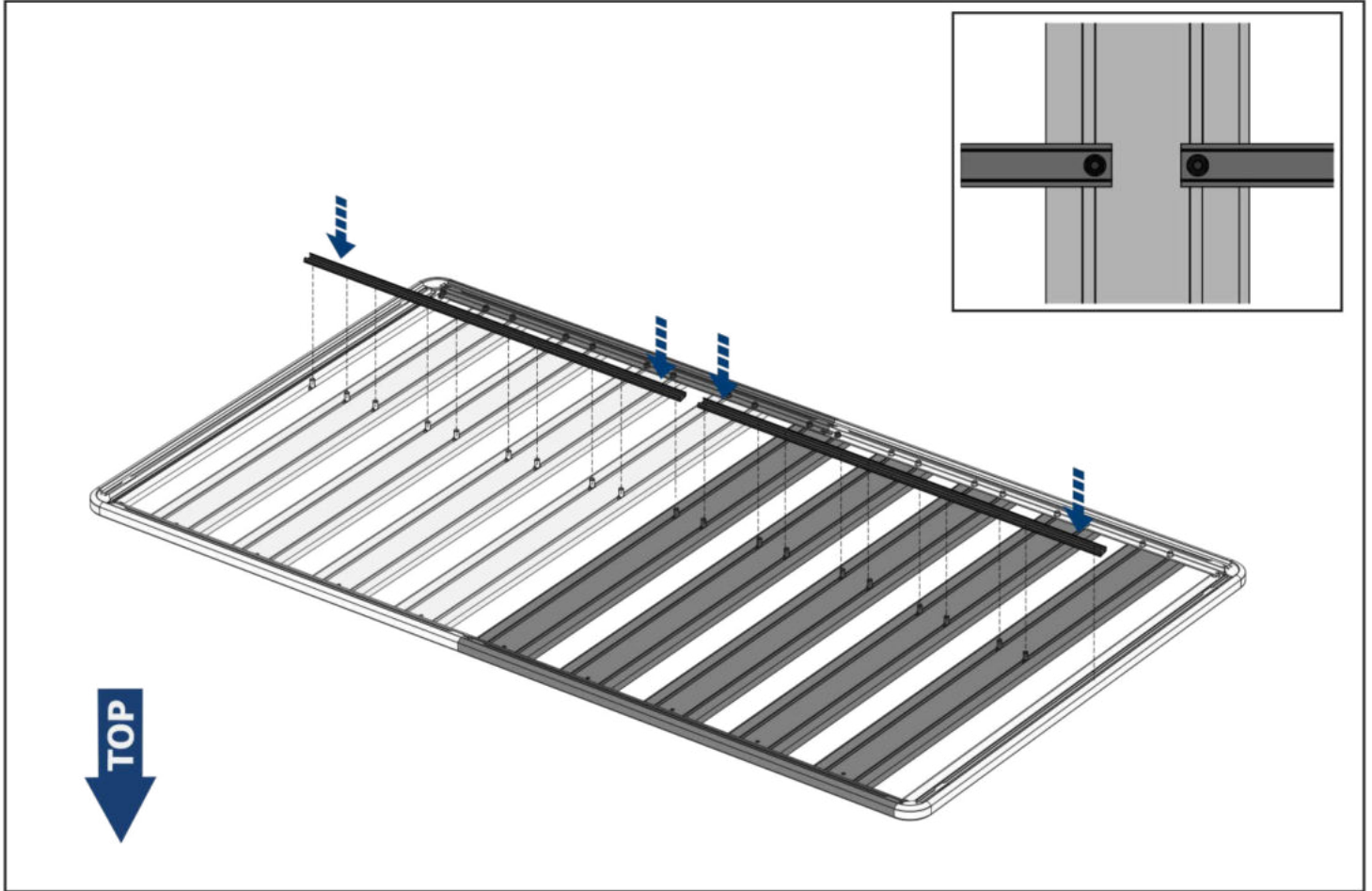



M8=30Nm

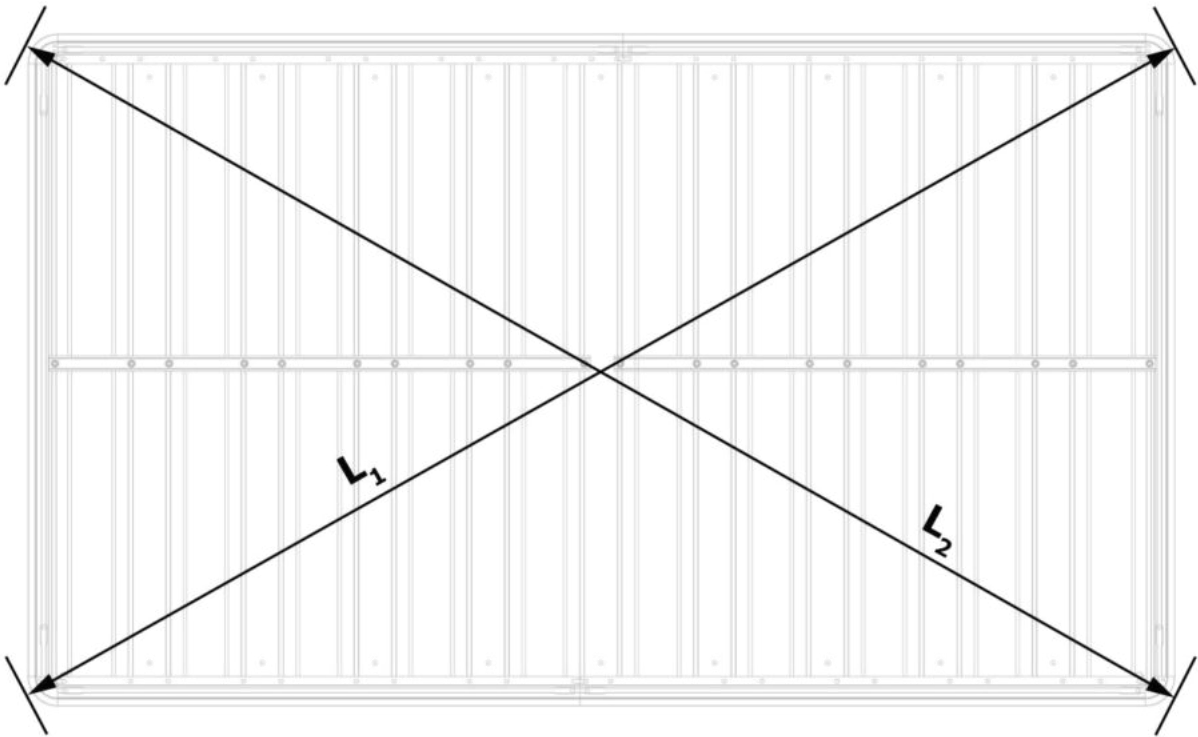
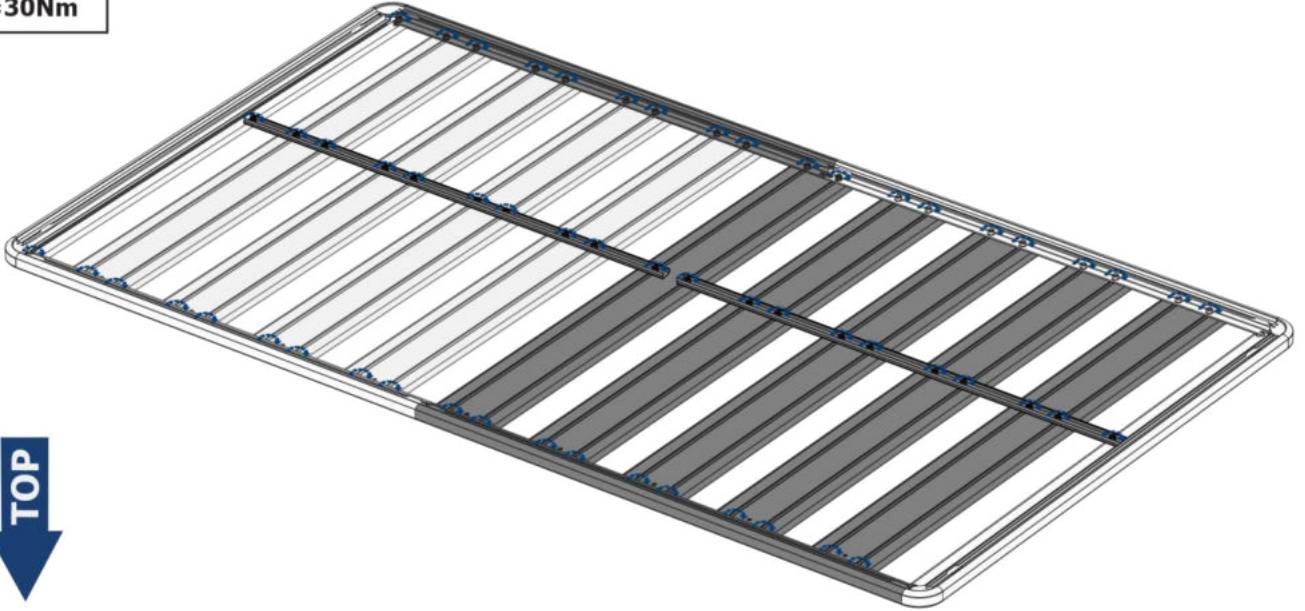

$$L_1 = L_2 \pm 1\text{mm}$$