

EN

## INSTALLATION MANUAL OF ROOF RAILS



**for: Land Rover Defender 110 (2020-)**

2M.3102.K



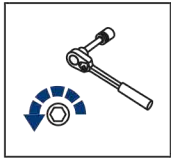

Regular fasteners

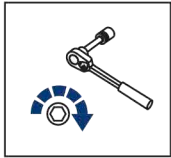

Regular fasteners



Screw a several turns



Loosen bolts

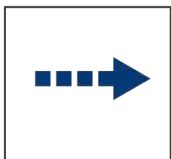



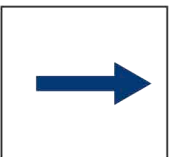

Movement Arrow











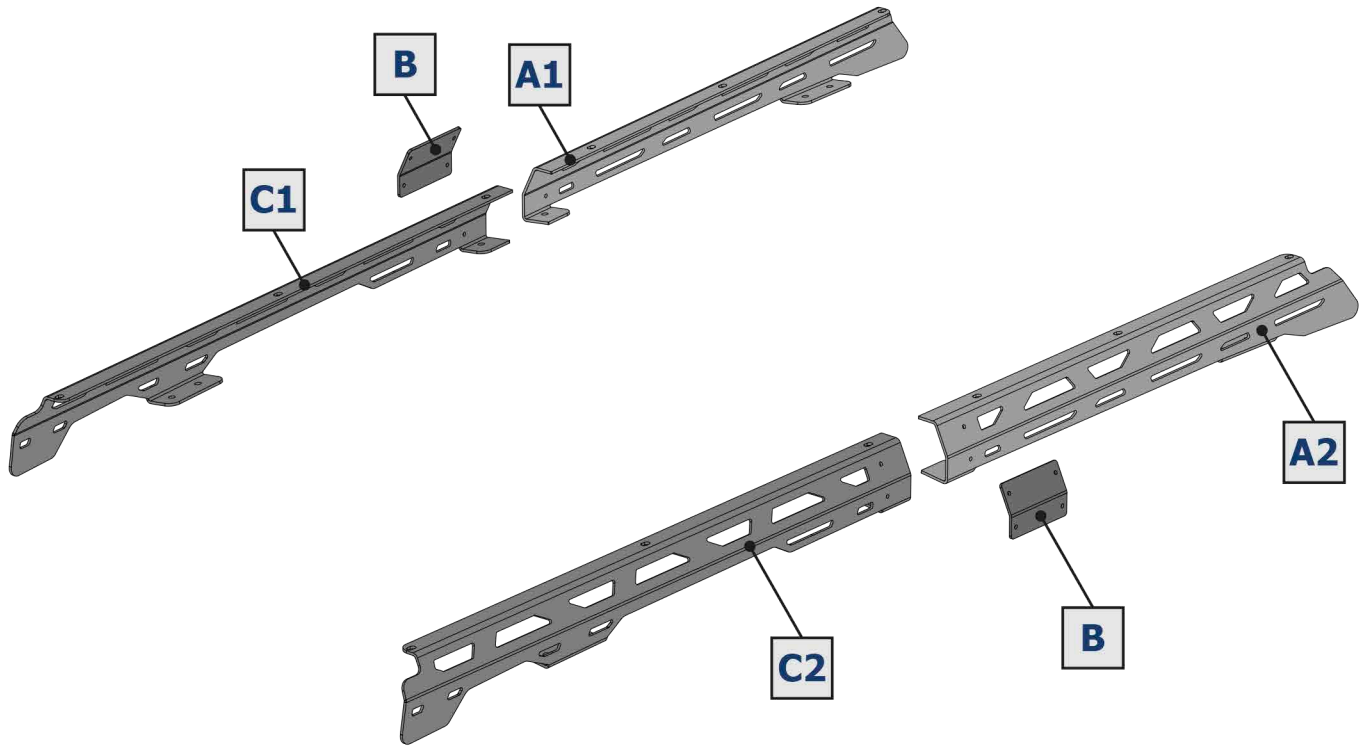

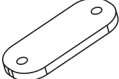
Location/Position Arrow



Screw Arrow

 Ratchet	 S - 13	 HEX S - 4	 Office Knife	 Wrench	10 mm 13 mm
---	--	---	--	--	----------------



<b>1</b>  x6	<b>2</b>  M8x20 x24	<b>3</b>  M6x20 x8	<b>4</b>  Ø8 x12	<b>5</b>  Ø6 x16	<b>6</b>  Ø8 x12
<b>7</b>  Ø8 x12	<b>8</b>  M6 x8	<b>9</b>  M8 x12	<b>10</b>  x1		

### IMPORTANT WARNING!

IT IS CRITICAL THAT ALL RIVAL PRODUCTS BE PROPERLY AND SECURELY ASSEMBLED AND ATTACHED TO YOUR VEHICLE. IMPROPER ATTACHMENT COULD RESULT IN AN AUTOMOBILE ACCIDENT, AND COULD CAUSE SERIOUS BODILY INJURY OR DEATH TO YOU OR TO OTHERS. YOU ARE RESPONSIBLE FOR ASSEMBLING AND SECURING ALL RIVAL PRODUCTS TO YOUR VEHICLE, CHECKING THE ATTACHMENTS PRIOR TO USE, AND PERIODICALLY INSPECTING THE PRODUCTS FOR ADJUSTMENT, WEAR, AND DAMAGE. THEREFORE, YOU MUST READ AND UNDERSTAND ALL OF THE INSTRUCTIONS AND CAUTIONS SUPPLIED WITH YOUR RIVAL PRODUCT PRIOR TO INSTALLATION OR USE. IF YOU DO NOT UNDERSTAND ALL OF THE INSTRUCTIONS AND CAUTIONS, OR IF YOU HAVE NO MECHANICAL EXPERIENCE AND ARE NOT THOROUGHLY FAMILIAR WITH THE INSTALLATION PROCEDURES, YOU SHOULD HAVE THE PRODUCT INSTALLED BY A PROFESSIONAL INSTALLER OR OTHER QUALIFIED PERSONNEL.

